

# WFO

## 100 YEARS

**"MAKE EVERY STEP A SAFE ONE"  
ANTI-SLIP SAFETY STAIR  
AND WALKWAY PRODUCTS**

**New  
Construction**  
Pages 3 – 13

**Existing  
Buildings**  
Pages 15–25

pg. 9

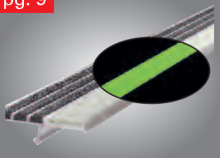

**NITEGLOW®**



**Stair Components & Systems**  
A Division of Eberl Iron Works, Inc.

**CATALOG 96**

**PROUDLY MADE IN THE**



pg. 11



**ALUMOGRIT®**

pg. 4

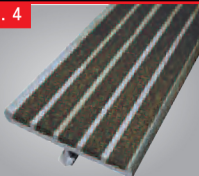

**SUPERGRIT®**

pg. 7



**SPECTRA®**



**MAKE EVERY STEP  
A SAFE ONE!**

pg. 15

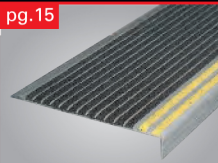

**STAIRMASTER®**

pg. 20



**FLEX-TRED®**



# WOOSTER PRODUCTS, INC.

1000 Spruce Street, P.O. Box 6005, Wooster, Ohio 44691

330-264-2844 • 800-321-4936 • Fax 330-262-4151

sales@wooster-products.com • www.woosterproducts.com

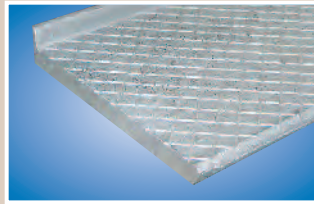

## INDEX BY TYPE NUMBER

### ABRASIVE CAST

Type	Page	Type	Page
100	11	112	13
101	11	113	13
101-SP	11	114	13
102	11	115	13
103	11	115-M	13
104	12	115-S	13
105	12	116	11
105-A	12	116-A	11
106	12	117	12
106-A	12	117-A	12
107	12	119	13
107-A	12	120	11
109	13	150	11
110T	13	250	11
111	13	950	11

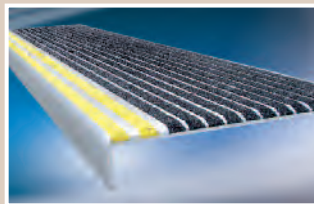

### EXTRUDED ALUMINUM

Type	Page	Type	Page
M231BF-NG	.9	138	.5
WP-1A	.7	141	.4
WP-2JT	.7	142	.4
WP-2C	.7	162	.15
WP-2D-NG	.9	182	.15
WP-2J	.7	221-BF-NG	.9
WP-2T	.7	231-BF	.4
WP-RN3SP-M	.6	232	.4
WP-3J	.7	238	.5
WP-3C	.7	241-BF	.4
WP-3JT	.7	242	.4
WP-3T	.7	300	.17
WP-3SP	.7	311	.17
WP-4J	.7	333FT	.15
WP-4C	.7	333FT-SN	.15
WP-4T	.7	333FT-NG	.9
WP-24	.7	333FT-SN-NG	.9
WP-24-NG	.9	365	.17
WP-24A	.7	431	.5
WP-24A-NG	.9	500, 500SN	.15
WP-RN2SG	.5	500NG	.9
WP-RN3SG	.5	511, 511SN	.15
WP-RN2SP	.6	540	.15
WP-RN3SP	.6	570	.15
WP-RN2-NG	.9	610	.5
WP-RN3SG-NG	.9	630	.15
WP-RN3SP-NG	.9	630A	.5
121BF	.4	630B	.5
121	.4	660	.15
122	.4	6100	.15
131	.4		
132	.4		
133	.5		

## INDEX

### Brand Names & Specs

Supergrit®	3-5
Spectra®	6-7
NITEGLOW®	8-9
Alumogrit®	10-12
Ferrogrit®	10-12
Thresholds	13
Stairmaster®	15-16
Flexmaster®	17
Flex-Tred®	20-21
Flex-Mark®	22
Safe-Stride®	20
Epoxy WP-70	20
Walk-A-Sured Water Clear Epoxy®	20
Walk-A-Sured Roll-On®	20

### Available Fasteners

### Installation Details

### Installation Tips

### Accessories

### Platforms, Floor Plates

### Existing Buildings

### Specifications

Cast	10
Flexmaster®	16
Spectra®	6
Supergrit®	3

### Stair Treads, Nosings

Cast	11
For OSHA Barrier-free	4-9
Spectra®	6-7
Supergrit®	3-5

### Structural Treads

Cast	12
------	----

### Thresholds

Curb Bar	11
----------	----

## ANTI-SLIP SAFETY STAIR and WALKWAY PRODUCTS

### Why specify Safety Stair and Walkway Products?

- **'Anti-Slip' Safety Treads** and **Safety Surfaces** provide code compliant protection for safe egress.
- The use of **Safety Stair** and **Walkway Products** can help protect the Building Owner, and pedestrians with the latest available technology for making stairs and walkways safe.

### Why specify 'Wooster'?

- A **'Wooster'** specification means the finest in **quality**, dependability and service.
- We are Safety Stair and Walkway experts! Wooster Products Inc has been furnishing **"state-of-the-art"** anti-slip Safety Treads and Safety Surfaces continuously since 1921!
- The most **competent production team** and **friendly sales and support staff** in the industry.

## WAREHOUSE STOCK

- A Wooster Products Advantage
- Significant Warehouse Stock!
- Most orders ship in 1-2 days
- Please check with customer service on specific nosings and current inventory levels.



Registered U.S. Patent Office



# SUPERGRIT® Safety Treads

### Specify Supergrit® For:

- Heavy Pedestrian Traffic
- Indoor, Outdoor Installation
- Excellent Safety Protection at Low Cost

- New Construction or Existing Stairs
- Non-combustible

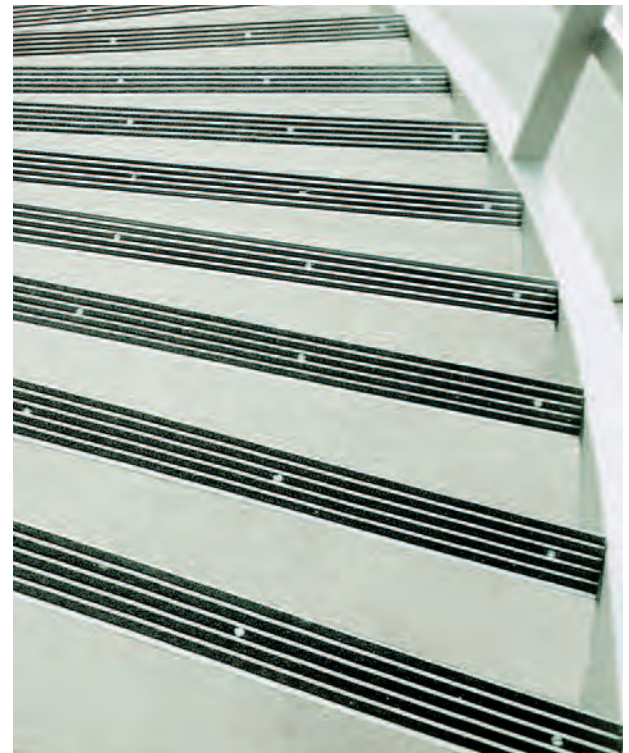
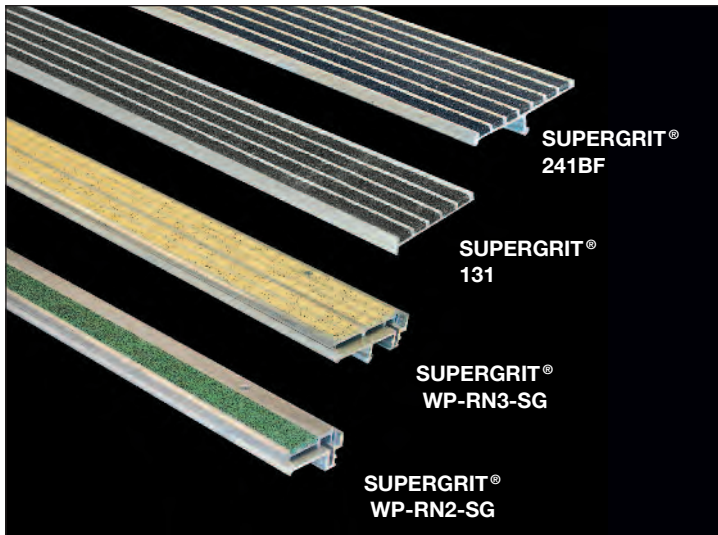

SUPERGRIT® TYPE 131

### Supergrit® Treads Provide...

A heat-treated, corrosion resistant, extruded aluminum base with satin/lacquered finish. The use of diamond-hard aluminum oxide in the filler assures long tread life under heavy pedestrian traffic. Supergrit® is designed for both inside and outside use.

### Supergrit® Features:

- Extruded aluminum base – abrasive filler
- Lengths to order, up to 12' 0" (3.66 m) in one piece
- Lengths over maximum to be made in equal sections
- Non-combustible
- High content of aluminum oxide abrasive
- 11 standard colors
- Colors extend throughout filler
- Protective tape available at extra cost



## SAFETY TREADS IN COLORS

Time-proven Supergrit® safety treads are available in colors for improved aesthetics.

### SUPERGRIT®/STAIRMASTER® COLORS

Standard color is black. Black will be shipped unless another color is specified. See color chart below for other colors available.

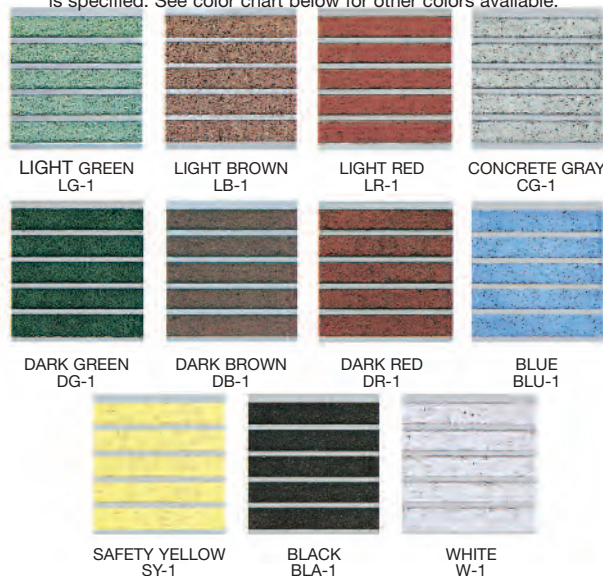

Actual tread color may vary slightly from printed sheet. Request tread sample if color is critical.

### SUPERGRIT® SPECIFICATION:

Provide Supergrit® type \_\_\_\_\_ safety nosings as manufactured by Wooster Products Inc. for interior and exterior stairs.

- Nosing base to be type 6063-T5 extruded aluminum.
- Anti-slip filler shall contain approximately 65% virgin grain Aluminum Oxide (AL<sub>2</sub>O<sub>3</sub>) abrasive.
- Nosings shall be non-combustible as tested under Federal Test Method Standard No. 501a, Method 6411.
- Type of anchor shall be as specified. See page 14 for anchor details.
- Nosings shall terminate not more than 4" (101.6 mm) from ends of steps for poured concrete stairs; for concrete-filled steel pan stairs, nosings shall be full length of steps less 1/8" (3.05 mm) clearance.
- Color shall extend uniformly throughout the filler; black color will be furnished if no other color is specified.
- Protective tape available upon request, at an extra cost.
- Protective tape should be removed as soon as possible once installed.

**Note:** Safety nosings going into new poured concrete or cement fill shall be installed before "INITIAL SET" of the concrete or cement occurs.

Nosings shall finish flush with the top of the traffic surface.

NEW CONSTRUCTION



Specify Supergrit® For:

- Heavy Pedestrian Traffic
- Indoor, Outdoor Installation

- New Construction or Existing Stairs
- Non-combustible

Please call Wooster Products Inc for current availability.

## SUPERGRIT® PROFILES FOR NEW CONCRETE STAIRS AND FOR STEEL PAN

MAXIMUM PIECE LENGTH IS 12 FEET

### THE DUAL PURPOSE STAIR NOSING BY 'WOOSTER'

**STEEL PAN:** Concrete filled, installed stringer to stringer less 1/8" clearance.

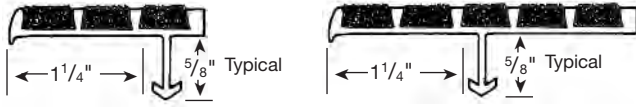

#### TYPE 121BF

1 7/8" (47.6 mm) wide  
1/4" (6.35 mm) thick

#### TYPE 231BF

3" (76.2 mm) wide, 1/4" (6.35 mm) thick

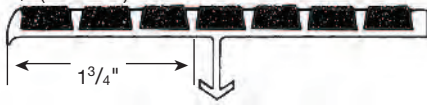

#### TYPE 241BF

4" (101.6 mm) wide, 1/4" (6.35 mm) thick

**121BF, 231BF AND 241BF AVAILABLE FROM STOCK**

THESE SECTIONS AVAILABLE WITH COUNTERSUNK HOLES AND FASTENERS



#### TYPE 121

1 7/8" (47.63 mm) wide, 1/4" (6.35 mm) thick  
nose 1/4" (6.35 mm) underside



#### TYPE 131

3" (76.2 mm) wide, 1/4" (6.35 mm) thick  
nose 1/4" (6.35 mm) underside



#### TYPE 141

4" (101.6 mm) wide, 1/4" (6.35 mm) thick  
nose 1/4" (6.35 mm) underside

#### DETAIL

Sure-hold anchor in concrete step.

Designed to install so that there is no projection past the face of the riser.



#### DETAIL

Sure-hold anchor in sloped riser steel pan step.

NOTE: Nose design provides better fit at formed edge of steel pan.

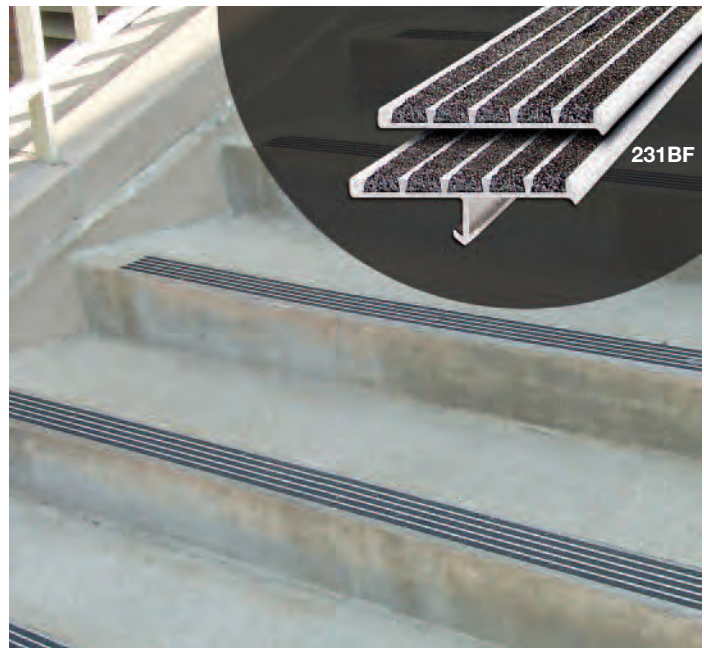
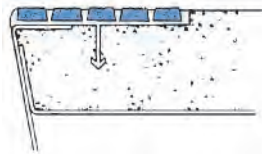

## SUPERGRIT® PROFILES FOR STEEL PAN CONCRETE-FILLED STAIRS

MAXIMUM PIECE LENGTH IS 12 FEET

Full stringer length, less 1/8" clearance.

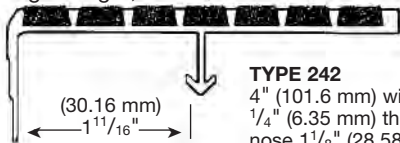

#### TYPE 242

4" (101.6 mm) wide  
1/4" (6.35 mm) thick  
nose 1 1/8" (28.58 mm) underside

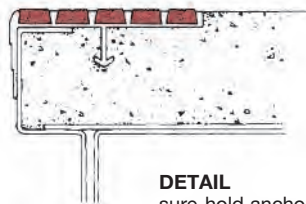

**DETAIL**  
sure-hold anchor in steel pan step

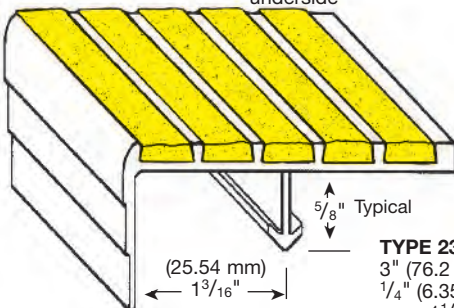

#### TYPE 232

3" (76.2 mm) wide  
1/4" (6.35 mm) thick  
nose 1 1/8" (28.58 mm) underside

SECTIONS NOT TO SCALE

THESE SECTIONS AVAILABLE WITH COUNTERSUNK HOLES AND FASTENERS

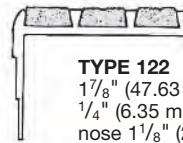

#### TYPE 122

1 7/8" (47.63 mm) wide  
1/4" (6.35 mm) thick  
nose 1 1/8" (28.58 mm) underside

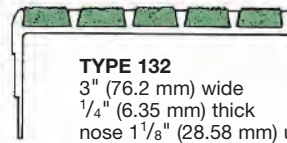

#### TYPE 132

3" (76.2 mm) wide  
1/4" (6.35 mm) thick  
nose 1 1/8" (28.58 mm) underside

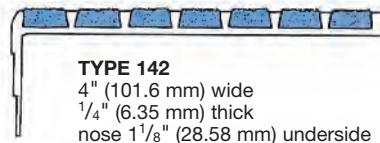

#### TYPE 142

4" (101.6 mm) wide  
1/4" (6.35 mm) thick  
nose 1 1/8" (28.58 mm) underside

**SUPERGRIT® 2-STAGE STAIR NOSING FOR STEEL PAN OR POURED CONCRETE STEPS**  
MAXIMUM PIECE LENGTH IS 8 FEET

**Specify SUPERGRIT® Replaceable Stair Nosings For:**

- Fast easy replacement if damaged
- Visual appearance and durability
- Secure anchorage
- Indoor or outdoor use
- Matching or contrasting color decor
- Non combustible
- Heavy pedestrian traffic
- Premium quality construction with no clatter and an architecturally clean design.
- Nosings can be furnished with disposable wood insert for use during construction phase. After construction nosing inserts are installed for fresh, clean appearance.
- Furnished with SUPERGRIT® Filler in a wide range of colors.
- Steel pan or poured concrete steps.

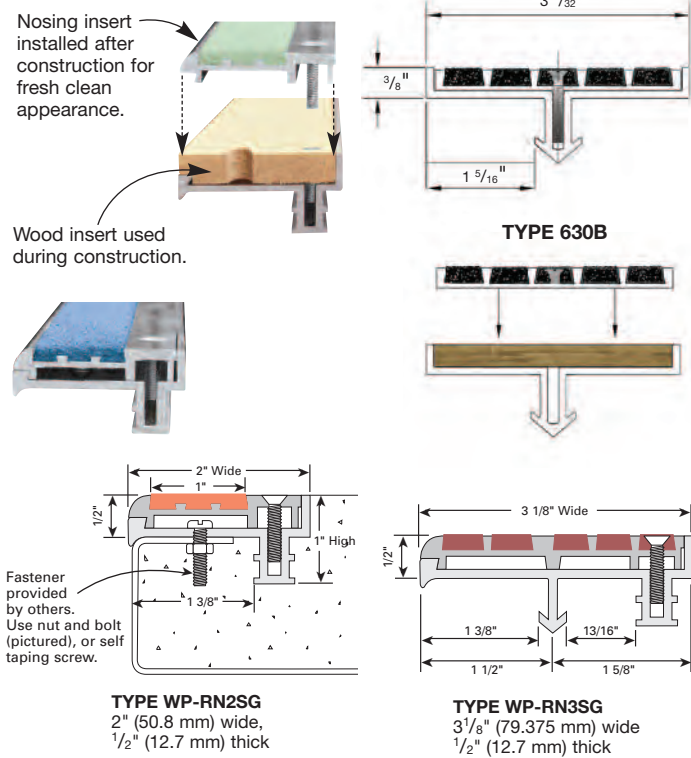

**FOR POURED CONCRETE OR STEEL PAN STAIRS**  
MAXIMUM PIECE LENGTH IS 12 FEET

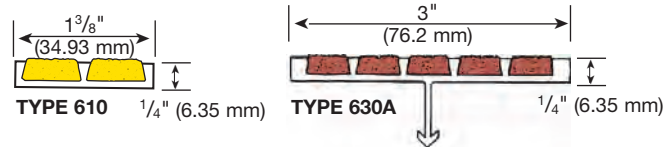

**HAS RECESS FOR TILE**

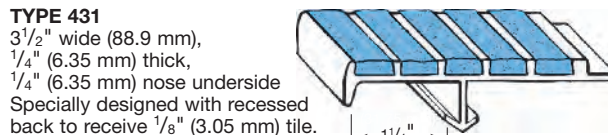

**FOR USE WITH SLOPED RISERS**

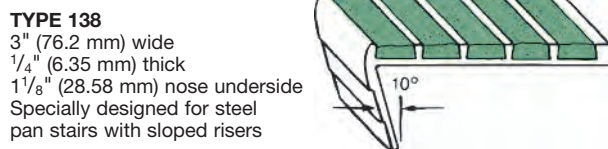

**HAS VARIABLE NOSE DEPTH**

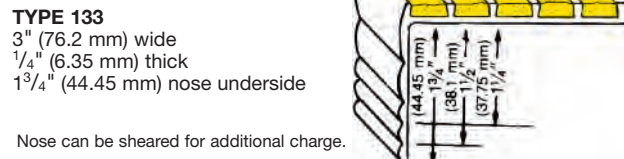

**SUPERGRIT® CURVED & MITERED TREADS**

FOR RADIUS APPLICATIONS – CONSULT FACTORY

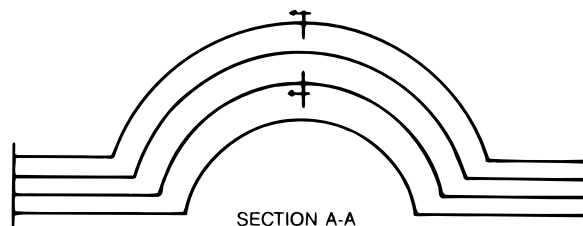

The tread provides non-slip protection as well as protection for the edge of the stair, preventing chipping and wear. Treads are shipped ready for installation.

- Lengths as required to 10' 0" (3.048 m)
- Curves and miters to drawings or template
- Minimum radius 3' 0" (914.4 mm)
- Guaranteed uniformity of width and thickness insures easy backing with floor tile
- Lead times increase for curved treads
- Only the following SUPERGRIT® treads are curved; types 121, 121BF, 131, 141, 231BF, 241BF, 630, 630A, 610

**NAVSEA LADDER TREADS**

Sizes 4" – 6" – 9" • MiL-T-24634 (SH)  
Custom Lengths • Full Treads • Cap Treads

**TYPE I FULL TREAD**

- 4" - Model 841
- 6" - Model 861
- 9" - Model 891



**TYPE II CAP TREAD**

- 4" - Model 842
- 6" - Model 862
- 9" - Model 892



\* National Safety Council information



**Specify Spectra® For:**

- Best Architectural Aesthetics
- Matching or Contrasting Color Decor
- Indoor or Outdoor Use
- Heavy Pedestrian Traffic
- Non-combustible



**SAFETY TREADS IN CONTRASTING COLORS**

Designed to enhance the safety and beauty of every architectural installation.

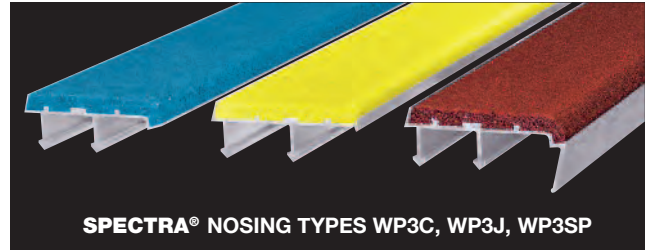

**SPECTRA® TREADS PROVIDE...**

A high content of aluminum oxide abrasive grit for long life and lasting beauty. Spectra's safety surface has easy maintenance features and insures excellent protection from liability of falls and injuries.

**SPECTRA® FEATURES:**

- Extruded aluminum base – abrasive filler
- Lengths to order, up to 10'0" (3.048 m) in one piece
- Lengths over maximum to be made in equal sections
- Anti-slip abrasive extending over radius of nose
- High content of aluminum oxide abrasive
- 18 standard colors
- "Clean" architectural lines
- Protective tape available at extra cost
- Non-combustible



**SPECTRA® SPECIFICATION:**

Provide Spectra® type \_\_\_\_\_ safety nosings as manufactured by Wooster Products Inc for interior and exterior stairs.

- Nosing base to be type 6063-T5 extruded aluminum.
- Anti-slip filler shall contain approximately 60% virgin grain Aluminum Oxide (AL<sub>2</sub>O<sub>3</sub>) abrasive.
- Binder is to be a fully-cured resilient type epoxy; epoxy binder to filler ratio to be 13% minimum for improved cleanability.
- Epoxy/Abrasive filler shall be securely bonded to the extruded aluminum base.
- Type of anchor shall be as specified. See page 14 for anchor details.
- Nosings shall terminate not more than 4" (101.6 mm) from ends of steps for poured concrete stairs; for concrete-filled steel pan stairs, nosings shall be full length of steps less 1/8" (3.05 mm) clearance.
- Color shall extend uniformly throughout the filler; black color will be furnished if no other color is specified.
- Protective tape available upon request at additional cost.
- Protective tape should be removed as soon as possible once installed.

**Note:** Safety nosings going into new poured concrete or cement fill shall be installed before "INITIAL SET" of the concrete or cement occurs.

Nosings shall finish flush with the top of the traffic surface.

**SPECTRA® TWO STAGE STAIR NOSING WITH REPLACABLE WOOD INSERT FOR PROTECTION DURING CONSTRUCTION**  
MAXIMUM PIECE LENGTH IS 8 FEET

- Premium quality construction with no clatter for an architecturally clean design.
- Designed for installation on steel pan stairs or poured concrete steps.
- Nosings can be furnished with disposable wood insert for use during construction phase. After construction anti-slip inserts are installed for a fresh, clean appearance.
- Furnished with Spectra filler in a wide range of colors.
- Nosings can be replaced if damaged, without costly demolition of stairs.
- For steel pan or formed concrete steps.
- Spectra® features Non-combustible per Federal Test 501a

- Fast easy replacement
- Visual appearance and durability
- Secure anchorage
- Indoor or outdoor use
- Matching or contrasting color decor
- Non combustible
- Heavy pedestrian traffic

**TYPE WP-RN2SP**  
2" (50.8 mm) wide  
1/2" (12.7 mm) thick

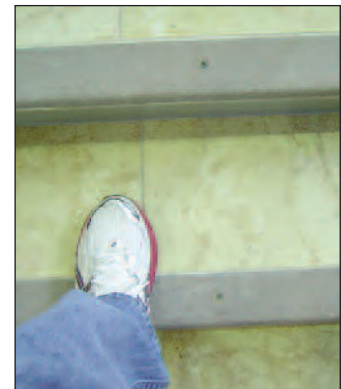
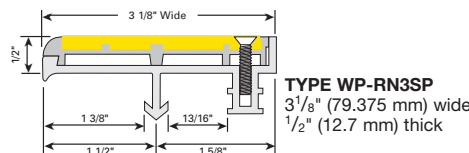
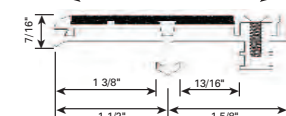
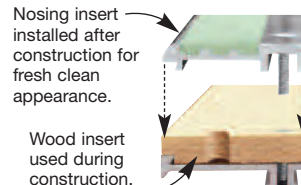
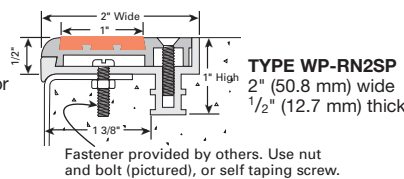

NEW CONSTRUCTION



Specify Spectra® For:

- Best Architectural Aesthetics
- Matching or Contrasting Color Decor
- Indoor or Outdoor Use
- Heavy Pedestrian Traffic
- Non-combustible

**Please call Wooster Products Inc for current availability.**

**SPECTRA® PROFILES FOR NEW CONCRETE STAIRS**

MAXIMUM PIECE LENGTH IS 10 FEET

Custom lengths to ± 1/16".

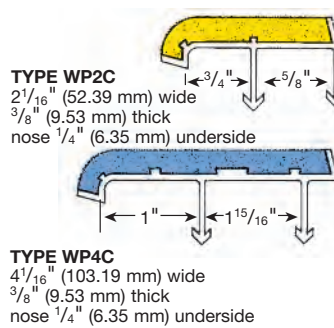
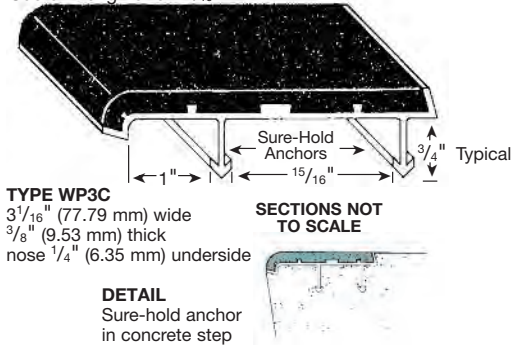

THESE SECTIONS AVAILABLE WITH COUNTERSUNK HOLES AND FASTENERS

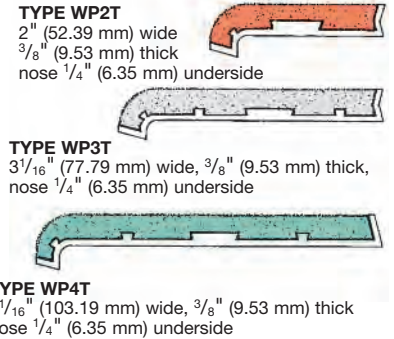

**SPECTRA® PROFILES FOR STEEL PAN CONCRETE-FILLED STAIRS**

MAXIMUM PIECE LENGTH IS 10 FEET

Generally installed full stringer to stringer length, less 1/8" clearance.

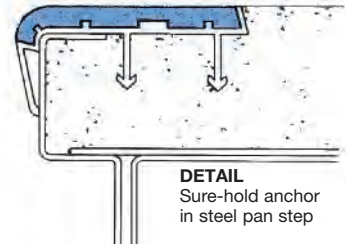
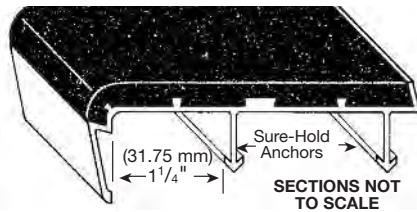

**SPECTRA® PROFILES FOR SLOPED RISER STEEL PAN STAIRS...**

MEETS OSHA BARRIER-FREE DESIGN, MAXIMUM PIECE LENGTH IS 10 FEET

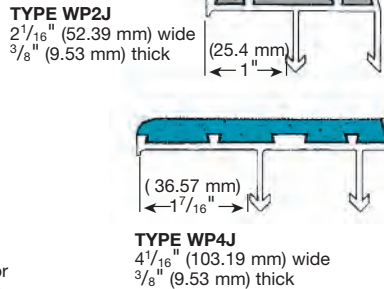
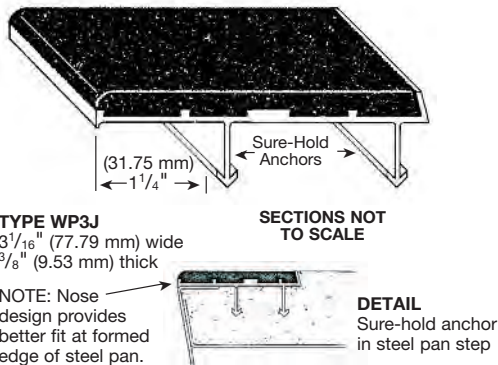

THESE SECTIONS AVAILABLE WITH COUNTERSUNK HOLES AND FASTENERS

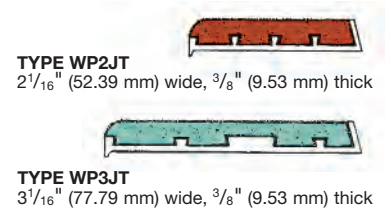

This series is designed to meet the OSHA requirements of the barrier-free code for stair construction.

MAXIMUM PIECE LENGTH IS 10 FEET

**SPECTRA® RECESSED INTO STEP SURFACE**

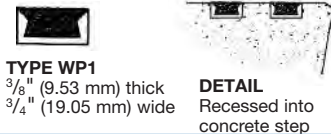

**SPECTRA® FOR NEW CONCRETE**

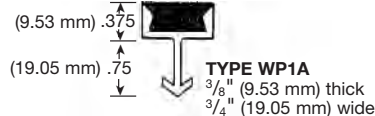

**CALIFORNIA TITLE 24 NOSINGS**

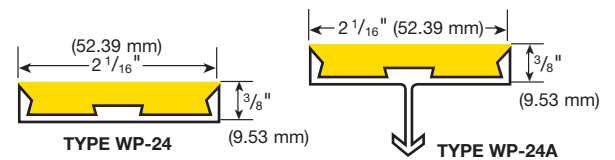

**SPECTRA® COLORS**

Standard color is black. Black will be shipped unless another color is specified. See color chart below for other colors available. Actual tread color may vary slightly from printed sheet. Request tread sample if color is critical.

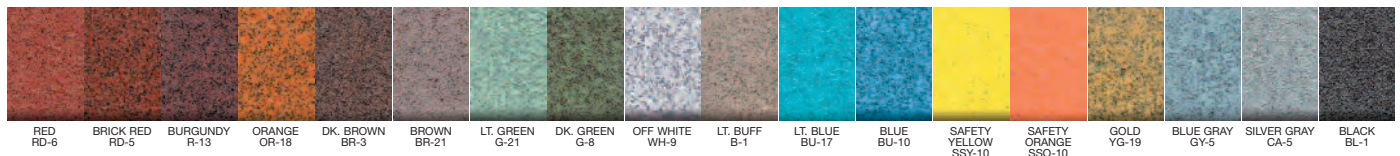



**NITEGLOW®**

**Anti-Slip Glow-in-the-Dark Safety Treads**

**IBC and IFC COMPLIANT!  
NYC MEA APPROVED!**

# NITEGLOW®

- Illuminate dark egress paths
- Entire photoluminescent area is slip resistant
- Recharged by any light source, natural or artificial



**WORLD TRADE CENTER SAFETY TREAD OF CHOICE**

## SAFETY GUIDANCE SYSTEMS

Bring your building into compliance with the NYC, International Building and International Fire Codes. Section 1024 of the IBC and IFC codes call for Photoluminescent markings to be used in egress exit stairwells of buildings over 75 feet tall.

- **CODE 1024.2.1 STEPS** – continuous stripe on leading edges – utilize models 333FT-NG, 333FT-SN-NG or 500-NG
- **CODE 1024.2.2 LANDINGS** – continuous stripe on the leading edge – utilize models 333FT-NG, 333FT-SN-NG or 500-NG
- **CODE 1024.2.3 HANDRAILS AND EXTENSIONS** – Stripe on the top of handrails – utilize model NG.HR1-1
- **CODE 1024.2.4 PERIMETERS** – solid stripe on landings and other floor areas within exit enclosures. Either wall or floor mounted. Utilize model 408.3
- **CODE 1024.2.5 OBSTACLES** – obstacles projecting more than 4" or below 6'6" shall be marked with alternating bands of luminescent and black strips – utilize model NG.HZ1-1
- **CODE 1024.2.6 DOORS FROM EXIT ENCLOSURES** – marked with a luminous exit symbol – utilize models NG.RML or NG.RMR (consult factory for additional signs)
- **CODE 1024.2.6.2 DOOR HARDWARE** – shall be marked with no less than 16 square inches of luminous material – utilize models NG.DHM, NG.HR1-1, or NG.AS1-1
- **CODE 1024.2.6.3 DOOR FRAME** – Top and sides of doors shall be marked with continuous luminous stripes – utilize models NG.HR1-1 or NG.AS1-1

- All NITEGLOW® nosings and treads meet current IBC and IFC codes. ASTM E 2072-74 and UL1994 •
- NYC MEA Approved, and in use, for over 10 years •
- NITEGLOW® pigment and anti-slip material is throughout product for maximum safety and durability•

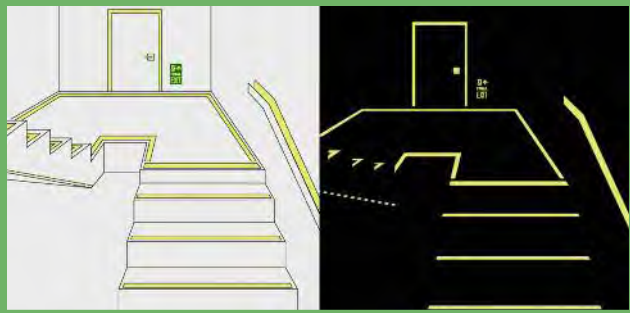

## GUIDELINES FOR STEPS & LANDINGS PHOTOLUMINESCENT (GLOW-IN-THE-DARK) REQUIREMENTS.

- The entire horizontal leading edge of each step and landing shall be marked with a solid and continuous stripe of photoluminescent material. The dimensions, distances and locations shall be uniform throughout.

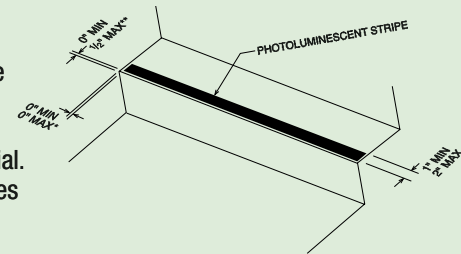

**WOOSTER PRODUCTS NITEGLOW®** includes grit for anti-slip safety. Other products do not.



## FEATURES

Our pigment is *embedded* in a hard epoxy mixture that meets all anti-slip and brightness codes. It is *not* a thin adhesive tape or coating with inadequate coefficient of friction ratings.

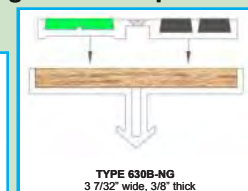
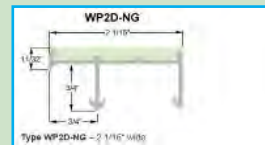

Glow in the dark treads are not designed to provide enough light to illuminate the dark egress path, but rather to provide luminescent outlines of the egress stairs.

**Wooster NITEGLOW® Products have been Tested and Approved for:** Brightness rating: ISO 17398:2004; Washability: ASTM D 4828-1994 (2303); Toxicity Bombardier: SMP 800-C; Radioactivity: ASTM D 3648-2004; Flame Spread: ASTM D 635-2003

800-321-4936 [www.woosterproducts.com](http://www.woosterproducts.com)

NEW CONSTRUCTION





**NITEGLOW®**

**Anti-Slip Glow-in-the-Dark Safety Treads**

Maximum piece length of all NITEGLOW® stair treads and nosings is 8 feet

**IBC and IFB COMPLIANT!  
NYC MEA APPROVED!**

**COMPLETE SYSTEM TO BRING YOUR BUILDING UP TO IBC, IFB, AND NYC CODE COMPLIANCE.**

**NITEGLOW® PHOTOLUMINESCENT STAIR NOSINGS & TREADS**

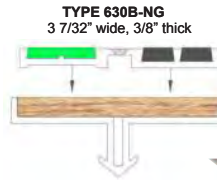
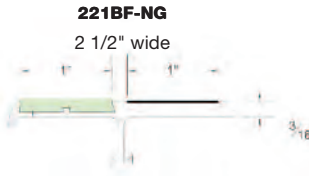
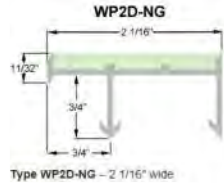
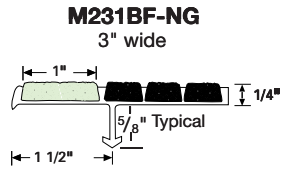
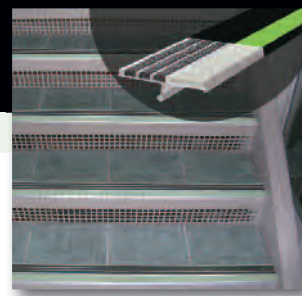

**NITEGLOW® TWO STAGE STAIR NOSING WITH REPLACABLE WOOD INSERT FOR PROTECTION DURING CONSTRUCTION**

- Fast easy replacement if damaged
- Visual appearance and durability
- Secure anchorage
- Wood insert for construction phase
- Steel pan or poured concrete steps
- Indoor or outdoor use
- Non-combustible
- Heavy pedestrian traffic
- Maximum length 8 feet

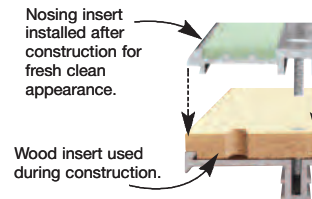
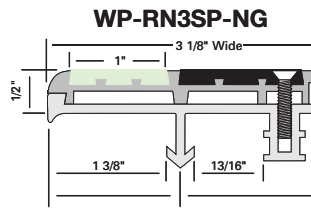
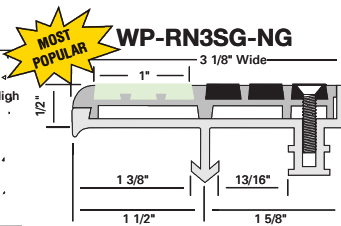
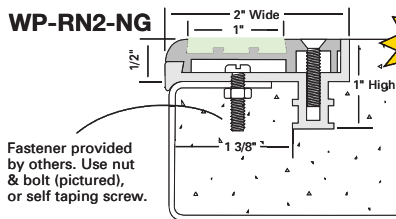

**STAIRMASTER® 333FT-NG**

- High quality nosing at the lowest cost. Easy to install using construction adhesive and/or pre-drilled holes. 1" wide NITEGLOW® stripe. Available in two styles.

**STAIRMASTER® 500-NG**

- Stairmaster 500-NG installed on stairways provides safety in two ways, prevents slips and falls and illuminates the front of the stairs for evacuation safety

**333FT-NG**  
3" Wide, NITEGLOW® is 1" wide

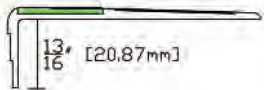

**333FT-SN-NG**  
3" Wide, NITEGLOW® is 1" wide

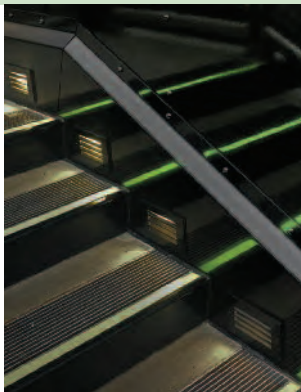
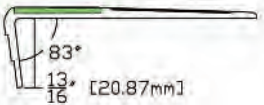

**500-NG**  
9" Wide, NITEGLOW® is 1-1/8" wide

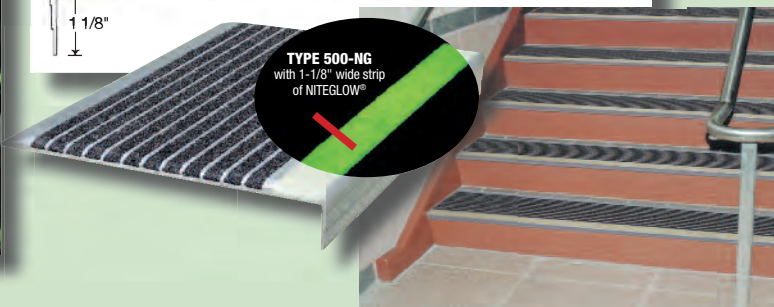

**PHOTOLUMINESCENT SIGNS AND TAPES**

**HANDRAIL TAPE NG.HR1-1**



**ALUMINUM STRIP NG.AS1-1**



**RUNNING MAN RIGHT NG.RMR**

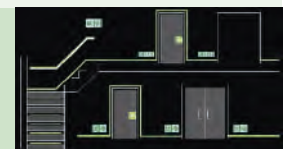

**HAZARD TAPE NG.HZ1-1**



**DOOR HANDLE MARKET NG.DHM**

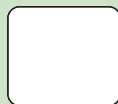

**RUNNING MAN LEFT NG.RML**



**UL 1994 Listed!**



For additional photoluminescent signage, please contact Wooster Products at: 1-800-321-4936 or sales@wooster-products.com

**25 Year Limited Warranty on Glow. Expect Service life GREATER than 50 years!**



### Specify Abrasive Castings For:

- Maximum Durability in Rough Use
- Indoor or Outdoor Use
- Resistance to Corrosive Environments
- Anti-Slip Safety Properties
- Ready to Install Convenience
- New Construction or Existing Buildings

## TREADS, NOSINGS AND THRESHOLDS FOR PROTECTION AND LONG WEAR

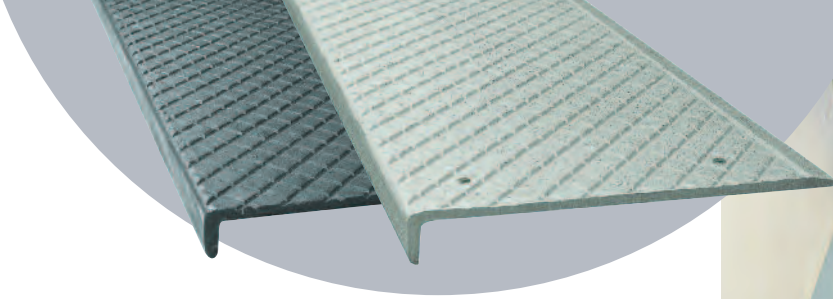

### ABRASIVE CASTINGS SPECIFICATION:

Provide Alumogrit® or Ferrogrit® type \_\_\_\_\_, size \_\_\_\_\_, safety treads/nosings as manufactured by Wooster Products Inc. for interior and exterior stairs.

- Abrasive shall be #20 virgin grain Aluminum Oxide (AL<sub>2</sub>O<sub>3</sub>) abrasive, integrally cast into the walking surface to a minimum depth of 1/32 inch (.79 mm).
- Safety nosings up to 6" (152.4 mm) deep with cross-hatched surface being installed into wet concrete shall have a "Marker Line" (Trademark 3571602) along the back edge.
- Concealed type anchors shall be slotted rivet type, integrally cast into the body of the nosing a minimum of 3/8 inch (9.53 mm). (Not mushroom type.)
- Cast metals used shall conform to the following specification:
  - **Alumogrit®** (Abrasive cast aluminum): No. 43 prime and secondary ingot; low copper content; corrosion-resistant.
  - **Ferrogrit®** (Abrasive cast iron): Class 20 iron; high silicon; machinable, hypereutectic.
- All holes or countersinks shall be machine-made. Screwheads shall not protrude above tread surface.
- All metal types shall have shot-blasted finish; Ferrogrit® treads and nosings to have one coat shop-black paint.
- Cross hatching and fluting shall be 1/16 inch (1.59 mm) deep minimum and shall be clean and well defined; treads and nosings shall be manufactured, packed and shipped so as to arrive at the jobsite in good condition.
- Nosings shall terminate not more than 4" (101.6 mm) from ends of steps for poured concrete stairs; for concrete-filled steel pan stairs, nosings shall be full length of steps, less 1/8" (3.05 mm) clearance.

**Note:** Safety nosings going into fresh poured concrete shall be installed before "Initial Set" of the concrete.

Non-structural stair nosings and treads for Poured concrete and steel pan concrete-filled stairs

#### ALUMOGRIT®

5/16" and 3/8" thick - nosing width to 6" - max. length 8'6"  
3/8" thick - over 6" to 12" width - max. length 6'

Types 101, 101SP, 100, 102, 110 and 120  
5/16" thick - over 6" to 12" wide - max. length 6'

Types 103, 104, 116, 116A and 105A  
5/16" thick - over 6" to 9" width - max. length 6'

#### FERROGRIT®

5/16" thick - nosing max. 6" wide - max. length 6'  
3/8" thick - nosing width to 6" - max. length 6'

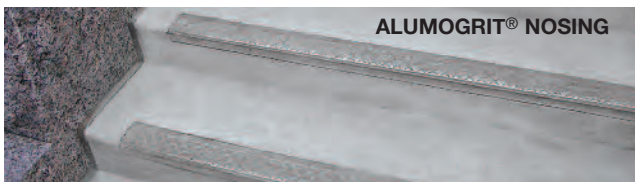

ALUMOGRIT® NOSING

### TYPE 116A – GREAT FOR EXISTING INDUSTRIAL STAIRWAYS AND/OR LANDINGS.

Wooster's quality cast treads, nosings and thresholds contain an even distribution of abrasive grit integrally cast into the surface for anti-slip protection and long wear. Width and length to order. Nosings that are set flush generally should be 3" (76.2 mm), 4" (101.6 mm) or 6" (152.4 mm) in width.

**SURFACE:** Abrasive cross-hatch is standard and will be furnished unless plain or fluted surface is specified. (Cross hatch pattern may not match up on sections being butted together.)

**FASTENERS:** 1/4" (6.35 mm) F.H.M. plated screws and nuts with steel wing anchors for fresh poured concrete or concealed integral anchors are available.

**DRILLING:** Standard drilling for nosings 3" (76.2 mm) in from ends and on approximate 12" (304.8 mm) centers in single, staggered or double row according to width. See page 14 for typical Anchor and Installation Details.

**DO NOT** predrill support structure before tread installation.

**LENGTH:** Up to 8'6" (2.59 m) in one piece for Alumogrit®. These maximum lengths do not apply to structural treads or platforms. Call Wooster Products for more details on maximum structural sizes.

### GUIDELINES FOR THE INSTALLATION OF METAL SAFETY TREADS OR NOSINGS INTO NEW CONCRETE OR STEEL PAN-FILLED STAIRS:

- ... The use of very large aggregate in the concrete mix may make placement of the safety nosing difficult.
- ... Safety nosing placement may be difficult in concrete with very low slump.
- ... Place the concrete into the stair forms or steel pans as quickly as possible; schedule pours so as to install the metal safety nosings quickly, **before the "initial set"** of the concrete occurs.
- ... Puddle the concrete, tamp the safety nosings to insure proper concrete formation around the anchors.
- ... Remove the protective tape as soon as practical.

**NOTE:** Most nosings, stair treads and other anti-skid products are manufactured to order. Please contact Wooster Products Inc. for current lead time. **Close stairway after pour; permit no use for 24 hours.**



# ABRASIVE CAST Safety Treads & Nosings

## Specify Abrasive Castings For:

- Maximum Durability in Rough Use
- Indoor or Outdoor Use
- Resistance to Corrosive Environments
- Anti-Slip Safety Properties
- Ready to Install Convenience
- New Construction or Existing Buildings

## MEETS ADA REQUIREMENTS

Please call Wooster Products Inc for current availability.

These sections available with concealed integral anchors, wing anchors, or countersunk holes (See page 14 for details).

Maximum Piece length is 8'6"

### POURED CONCRETE

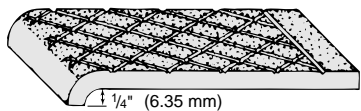

**TYPE 101** – Nose 1/4" (6.35 mm) lip.  
Chief use: as nosings, formed concrete stairs.  
Tread installed flush all around.

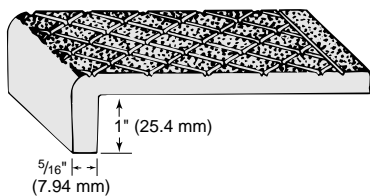

**TYPE 116** – Nose depth 1" (25.4 mm) standard.  
Chief use: as nosings, formed concrete stairs  
where deeper lip is desirable.

### FOR EXISTING STAIR REPAIR

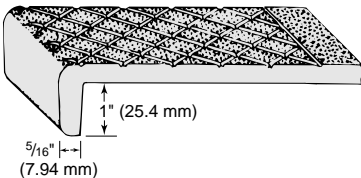

**TYPE 116A** – Nose depth 1" (25.4 mm) standard.  
Chief use: on top of existing steps for repair and  
modernization.

### STEEL PAN

Generally installed full stringer to stringer  
length, less 1/8" (3.05 mm) clearance.

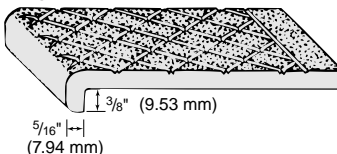

**TYPE 101SP** – Nose 3/8" (9.53 mm).  
Chief use: as nosings on steel-pan  
concrete-filled stairs or on existing steps.

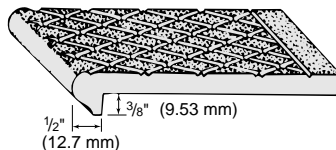

**TYPE 102** – Nose 1/2" x 3/8" (12.7 mm x  
9.53 mm). Chief use: as nosings on  
steel-pan stairs. Can also be used  
structurally with bent-plate risers.

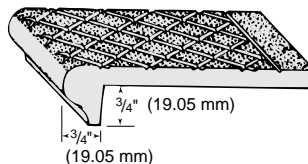

**TYPE 103** – Nose 3/4" x 3/4" (19.05 mm x  
19.05 mm). Chief use: as structural treads  
with bent-plate risers or as nosings full  
width of stair.

### MISCELLANEOUS USES



**TYPE 100**  
Square edges. Chief uses: floor plates,  
trench covers, stair landing platforms,  
expansion joint covers.



**TYPE 110**  
Rounded edges. Chief uses: Expansion  
joint covers, platforms around  
machinery, deck treads.

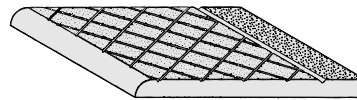

**TYPE 120**  
One edge rounded. Chief use: nosings  
on steel grating treads and for special  
conditions, usually superimposed.



**TYPE 950**  
Ladder Rung.  
Alumogrit® 2"x18" piece size

### CONCRETE CURBS

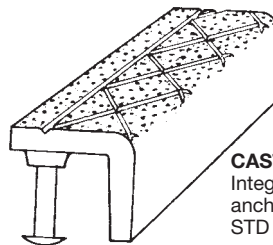

**CAST:**  
Integral  
anchors  
STD

**TYPE 150**  
1 1/2" x 1 1/2" x 3/8"  
(38.1 mm x 38.1 mm x 9.53 mm)  
**Alumogrit 6' (1.83m) max length**  
**Ferrogrit 5' (1.52m) max length**

**TYPE 250**  
2 1/2" x 2 1/2" x 1/2"  
(63.5 mm x 63.5 mm x 12.7 mm)  
**Alumogrit 6' (1.83m) max length**  
**Ferrogrit 5' (1.52m) max length**  
**(Steel Anchor ONLY)**

Consult factory when holes for  
fastening are required.



- Ferrogrit® is not recommended for corrosive environments.
- Ferrogrit® is not recommended for outdoor use due to possible rust appearance.
- Castings are subject to usual foundry draft, tolerances and thickness  $\pm 1/8"$ .
- Nosings may show a parting line on the nose surface.
- Standard measurements are from top of the leading edge.
- Custom lengths to  $\pm 1/16"$ .
- Standard hole size 1/4" with countersunk hole tops.
- Standard depths; 3", 4" and 6"
- Standard drilling; 3" from ends on approximately 12" centers.
- Beveled treads. Contact factory on availability per application.
- Lengths over maximum to be made in equal sections.



# ABRASIVE CAST STRUCTURAL Ferrogrit® and Alumogrit® Treads, Platforms & Cast Thresholds

## Specify Abrasive Castings For:

- Maximum Durability in Rough Use
- Indoor or Outdoor Use
- Resistance to Corrosive Environments
- New Construction or Existing Stairs
- Ready to Install Convenience
- Anti-Slip Safety Properties
- Extreme Field Conditions

## TREADS, NOSINGS AND THRESHOLDS FOR PROTECTION AND LONG WEAR



ALUMOGRIT®  
STRUCTURAL TREADS

NOTE: Thicknesses are minimum for casting purposes and not always sufficient for structural strength. Where width exceeds 18" (457.2 mm), maximum piece length 6'0" (1.83 m). Where width exceeds 38" (965.2 mm), maximum piece length 5'0" (1.52 m). Color may vary from piece to piece for all metals. Cross-hatched, or flutes may not match when multiple sections are used.

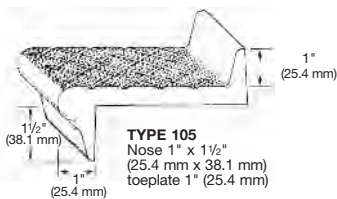

**TYPE 105**  
Nose 1" x 1 1/2"  
(25.4 mm x 38.1 mm)  
toeplate 1" (25.4 mm)

Chief use: as structural treads. Nosing and toeplate can be drilled for attaching flat plate risers, when specified.

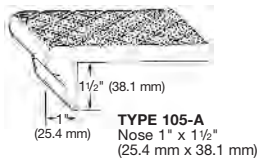

**TYPE 105-A**  
Nose 1" x 1 1/2"  
(25.4 mm x 38.1 mm)

Chief use: as structural treads or front of landing.

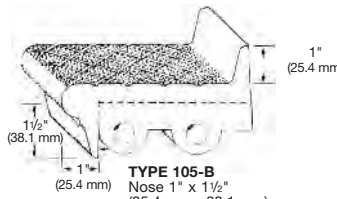

**TYPE 105-B**  
Nose 1" x 1 1/2"  
(25.4 mm x 38.1 mm)

Chief use: as structural treads. Nosing and toeplate can be drilled for attaching flat plate risers, when specified.

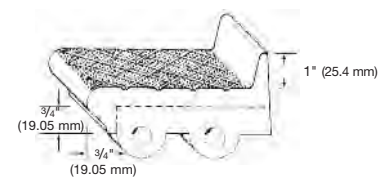

**TYPE 107**

Chief use: as structural treads. Nosing and toeplate can be drilled for attaching flat plate risers, when specified.

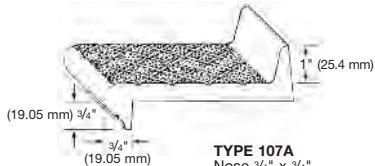

**TYPE 107A**

Nose 3/4" x 3/4"

(19.05 mm x 19.05 mm), toeplate 1" (25.4 mm)

Structural tread fastened to carrier angles on stringers.

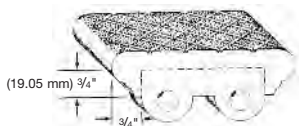

**TYPE 106**

Double nose tread, reversible. End lugs provided for bolting treads directly to stringers.

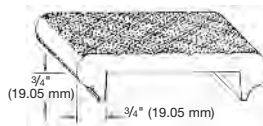

**TYPE 106A**

Double nose tread, reversible. Chief use: as structural tread supported by carrier angles on stringers.

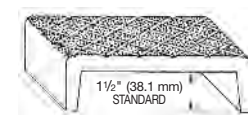

**TYPE 117**

Double nose tread, reversible. Chief use: as structural tread fastened to carrier angles on stringers.

**TYPE 117A**  
Double nose, reversible. Chief use: marine and industrial ladders. Treads bolt directly to stringer.

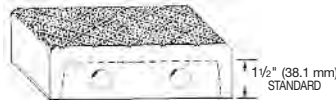

**TYPE 104**  
Nose 1" x 1"  
(25.4 mm x 25.4 mm)

Chief use: as structural treads with bent-plate risers or superimposed on existing steps.

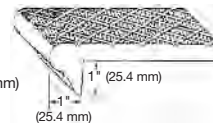

### MINIMUM THICKNESS TABLE FOR DRILLING ON STRUCTURAL TREADS

SPAN	To 4' 0"	To 5' 0"
All Metals	1/2" (12.7 mm)	5/8" (15.88 mm)

NOTE: Thicknesses are minimum for casting purposes and not always sufficient for structural strength.

### STANDARD HOLE SPACING FOR TREADS WITH LUGS

Hole spacing for self-supporting treads. Maximum length 5'0". All treads are cast with truss ribs when required.

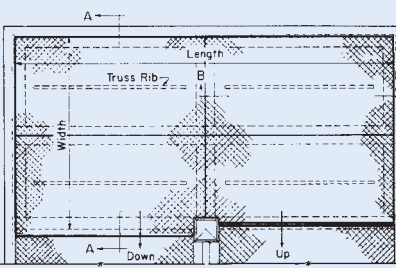
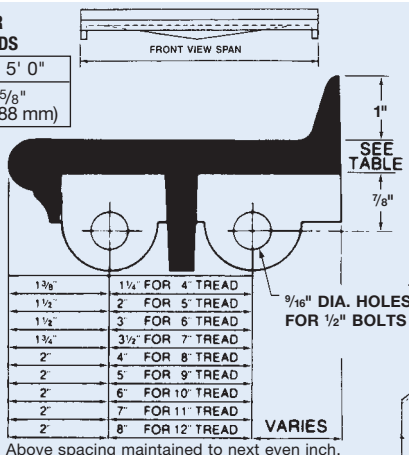

PLATFORM PLAN VIEW

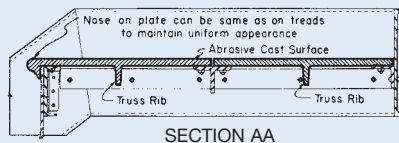

SECTION AA

### NOTE:

- Platforms manufactured in sections.
- Toeplates are added as required.
- Matching nosings are used on treads and platforms.
- Truss ribs are added when required for structural strength.
- Ferrogrit treads and platforms are furnished painted black; other metals have shotblasted finish.
- Standard surface furnished is abrasive cross hatched. Plain and fluted surfaces are also available.
- Supporting structural steel and fasteners are "by others".
- Various tread styles are available for attaching to carrier angles, or bolting directly to stair stringers.
- Sections are not "to scale".
- Attachment hole spacing for treads and platforms is "as detailed" for each job.
- Structural treads are custom made per application.
- Maximum structural tread length 5'0"

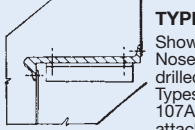

**TYPE 105**

Shown attached to carrier angles. Nose and toeplate have been drilled for closed riser plates. Types 103, 104, 105A, 105, 106A, 107A, and 117 can be drilled for attachment to carrier angles.

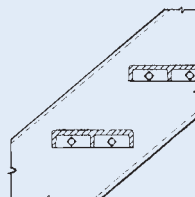

**TYPE 117A**

Shown with end lugs for mounting directly to stair stringer. No carrier angles are required. Types 105B, 106, 107, and 117A can be used this way.

NEW CONSTRUCTION



# ABRASIVE CAST STRUCTURAL Ferrogrit® and Alumogrit® Treads, Platforms & Cast Thresholds

## Specify Abrasive Castings For:

- Maximum Durability in Rough Use
- Indoor or Outdoor Use
- Resistance to Corrosive Environments
- New Construction or Existing Stairs
- Ready to Install Convenience
- Anti-Slip Safety Properties
- Extreme Field Conditions

## MEETS ADA REQUIREMENTS

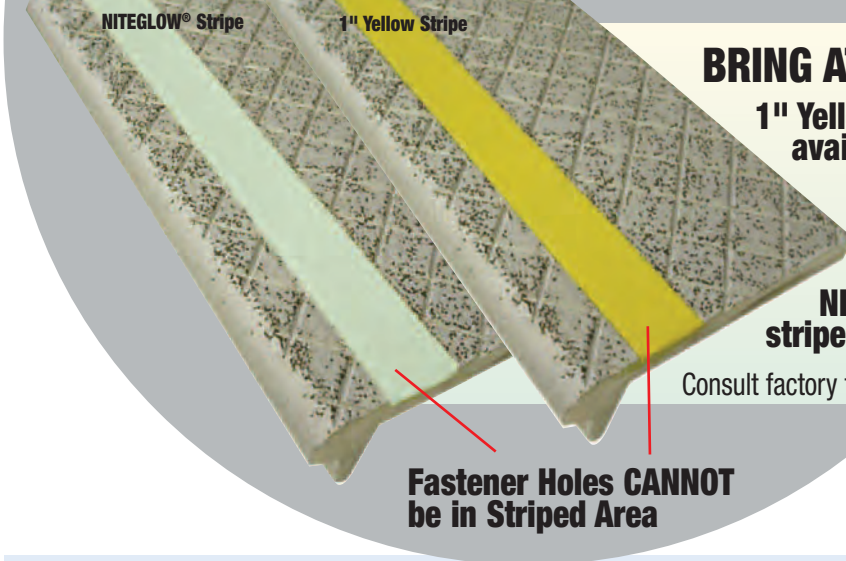

## BRING ATTENTION TO EDGE OF THE STEP!

1" Yellow Stripe or NITEGLOW® Stripe available on nosing or treads.

Nosings or treads **MUST BE** at least 3/8" thick and at least 4" wide.

Available in 1" or 2" Yellow, Black, or NITEGLOW stripes. 3" or 4" wide side stripes are also available.

Consult factory for stripe location and additional cost.

**Fastener Holes CANNOT be in Striped Area**

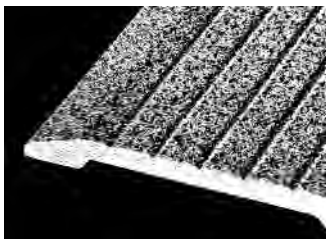

FLUTED SURFACED THRESHOLD

"Wooster" abrasive cast thresholds are cast to order from a large selection of architectural designs as shown. They are of highest quality and heavy duty construction in these metals:  
ALUMOGRIT®: abrasive cast aluminum  
FERROGRIT®: abrasive cast iron  
**FASTENERS:** Thresholds are drilled and countersunk for 1/4" (6.35 mm) screws unless other fasteners are specified.  
**NOTCHING:** Threshold ends can be factory notched for fast jobsite installation if frame details are furnished.  
**SPECIFICATIONS:** See page 10 for casting specifications.  
**LENGTHS:** Lengths to order up to 8' 6" (2.59 m) maximum in one piece.  
**SPECIAL PROFILES:** Special shapes up to 18" (457.2 mm) are available if details are provided.

\*Meets A.D.A. Requirements

### SADDLE TYPES\*



**TYPE 110** - Widths and heights as required. Fluted, plain, or cross hatch surface 1/4" (9.53 mm) thick.



**TYPE 111** - Standard 4" (101.6 mm), 5" (127 mm), 6" (152.4 mm) widths. Standard height 1/2" (14.29 mm), surface fluted. Other widths and heights to order.



**TYPE 114** - Standard 4" (101.6 mm), 5" (127 mm), 6" (152.4 mm) widths. Standard height 1/4" (9.53 mm), surface fluted. Other widths and heights to order.



**TYPE 115** - Standard 4" (101.6 mm), 5" (127 mm), 6" (152.4 mm) widths. Standard height 1/2" (12.7 mm). Other widths and heights to order. Fluted surface.

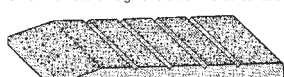

**TYPE 115M** - Standard 4" (101.6 mm), 5" (127 mm), 6" (152.4 mm) widths. Standard height 1/2" (12.7 mm). Other widths and heights to order. Fluted surface.

### STOP TYPES

(50.8 mm for 101.6 mm, 12.7 mm widths)  
2" for 4", 5" widths  
2 1/2" for 6" width  
(63.5 mm for 152.4 mm width)

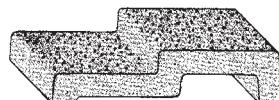

**TYPE 112** - Standard 4" (101.6 mm), 5" (127 mm), 6" (152.4 mm) widths. Height under door 1/4" (16 mm). Other heights and intermediate dimensions to order. Plain surface.

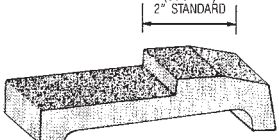

**TYPE 113** - Standard 4" (101.6 mm), 5" (127 mm), 6" (152.4 mm) widths. Height under door 1/4" (22.23 mm). Other heights and intermediate dimensions to order. Plain surface.

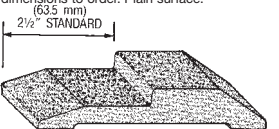

**TYPE 115S** - Standard 4" (101.6 mm), 5" (127 mm), 6" (152.4 mm) widths. Height under door 1/4" (12.7 mm). Other heights and intermediate dimensions to order. Plain surface.

### HOOK STRIP TYPES

Styles of Hookstrip furnished with Types 109 and 119 thresholds. Specify style.

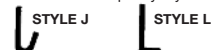

**TYPE 109**  
Standard 4" (101.6 mm), 5" (127 mm), 6" (152.4 mm) widths. Other widths to order. Made in 1/2" (12.7 mm). Other heights and intermediate dimensions to order. Fluted surface.



**TYPE 119**  
Standard 4" (101.6 mm), 5" (127 mm), 6" (152.4 mm) widths. Other widths to order. Made in 1/4" (16 mm), height only. Fluted surface. Hookstrip for door included.

### TYPICAL INSTALLATIONS

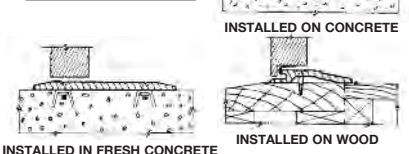

\* National Safety Council information

## FRESH CONCRETE

### SURE-HOLD ANCHOR

Sure-Hold anchors run full length of tread for positive anchorage and quick installation. Since Sure-Hold anchors are concealed, no bolt holes appear on the tread surface. Available as shown on nosings. Use installation tape to attach nosing to pan before pour.

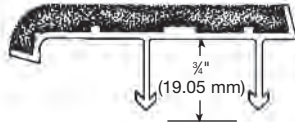

### WING TYPE ANCHOR FOR CAST AND EXTRUDED NOSINGS

Steel wing anchors, bolts, and nuts are furnished for field attachment into factory-drilled and ctsk. holes, prior to tread installation. from ends on approx. 12" (304.8 mm) centers. In single, staggered or double row, according to tread width. Can be furnished on most types if specified. 3/4" or 1/2" length – FHMS. Wing metal, standard mild steel. Stainless steel upon request. Tapcon screws also available for cast nosings and treads

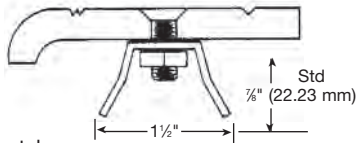

### CONCEALED INTEGRAL ANCHOR

This concealed type anchor can be furnished on types 101, 101-SP, 116, 102, 103, 104, 105A, 100 but **MUST BE SPECIFIED**.

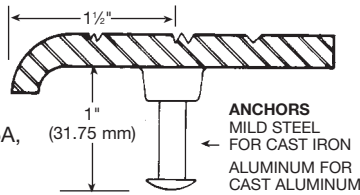

## EXISTING CONSTRUCTION



**WOOD OR MACHINE SCREWS**



**SILVER TAPCON SCREWS**

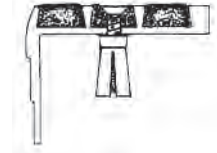

**SCREW & SHIELDS**

Treads being superimposed on existing stairs can be furnished pre-drilled and ctsk. for wood, machine or Tapcon screws. Standard spacing is 3" (76.2 mm) in from each end, approx. 12" (304.8 mm) centers, in single, staggered, or double row, according to tread width. Will furnish #10 screws. Zinc standard, stainless steel available upon request. Can be used with heavy duty construction adhesive or installation tape.

### BOLTED TO STEEL PAN RETURN

Nut and Bolt anchorage can be provided for new steel pan stairs. Pan return must be 1" (25.4 mm) minimum. Specify pan return depth for drilling purposes. Can be furnished on types WP-2, WP-RN2SG, WP-RN2SP, WP-RN2-NG, WP-3, WP-RN3SG, WP-RN3SP, WP-RN3SG-NG, WP-RN3SP-NG, 122, 132, 138, 142, 133, 162, 101-SP, 102, 103, but **MUST BE SPECIFIED**. Standard hole spacing is 3" (76.2 mm) from ends on approx. 12" (304.8 mm) centers. Zinc standard, stainless steel available upon request.

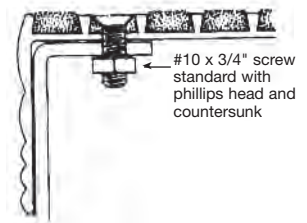

## AVAILABLE TO PURCHASE:

### PROTECTIVE TAPE

Nosings for new construction can be furnished with protective tape. This tape should be removed soon after stairs are installed. Tape should not be left on treads longer than 30 days.

### INSTALLATION TAPE

Two Sided Tape:

- Use as metals barrier in steel stair applications.
- Use to secure nosings to steel pans before pour.
- Use to install renovation treads indoors or outdoors.

Available in four sizes 3/4", 6", 8 1/2", 10 1/2"

## INSTALLATION DETAILS

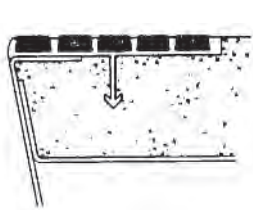

TYPE 231 BF Sure-Hold anchor in sloped riser steel pan step.

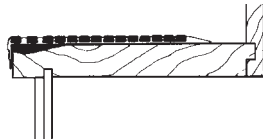

Type 500 Stairmaster® installed on wood step (wood screws available). If steps are other than wood, use screws with expansion shield or nut and bolt or Tapcon screws and an application of construction adhesive.

## TYPICAL INSTALLATION DETAILS FOR WOOSTER SAFETY TREADS



Type WP3C with integral Sure-Hold anchor in new concrete stair.

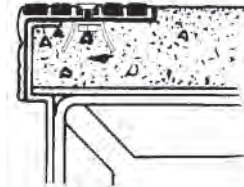

Type 133 Supergrit® with wing anchors in concrete filled steel pan.



Type 101 with wing type anchors in poured concrete stair.



Type 101SP with concealed integral anchor in steel pan stair.

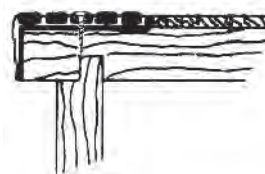

Type 142 Supergrit® attached to wood tread and backed with tile, carpet, or other material.



# STAIRMASTER® For Existing Stairs

**5-Year  
Warranty**  
on material and workmanship.

### Specify Stairmaster® For:

- Heavy Pedestrian Traffic
- Indoor, Outdoor Installation
- Excellent Safety Protection at Low Cost
- For Existing Stairs
- Non-combustible



## SPECIFY “STAIRMASTER®” FOR WORN AND SLIPPERY STAIRS

Stairmaster® Safety Treads are designed for the modernization and restoration of all types of stairs, while also providing excellent anti-slip protection.

Two-tone treads with contrasting color available.

Stairmaster® Safety Treads provide a fast and economical alternative to removal and reconstruction of a stairway.

Woooster Products Leveling Compound is available to fill/level worn steps before installing Stairmaster® treads.

Use construction adhesive in addition to mechanical fasteners for the best installation results.

See page 3 for material specifications.

- Special tread sealer available for wood or saltwater applications.



**STAIRMASTER® ON CONCRETE STAIR, CUT TO FIT AROUND THE POST & THE LENGTH OF THE STAIR WITH SQUARE ENDS.**



**STAIRMASTER® ON WOOD STAIR, CUT SHORTER THAN THE LENGTH OF THE STAIR WITH BEVELED ENDS.**

Most styles available up to 12' 0" in one section. Maximum piece length on type 333FT, 6100, 511SN and 511 is 8' 0". Drilled and countersunk holes are standard unless otherwise specified. **Beveled ends, countersunk holes and tapcon screws are standard, unless specified.**



Special twin visibility surfaces make the front edge more visible.

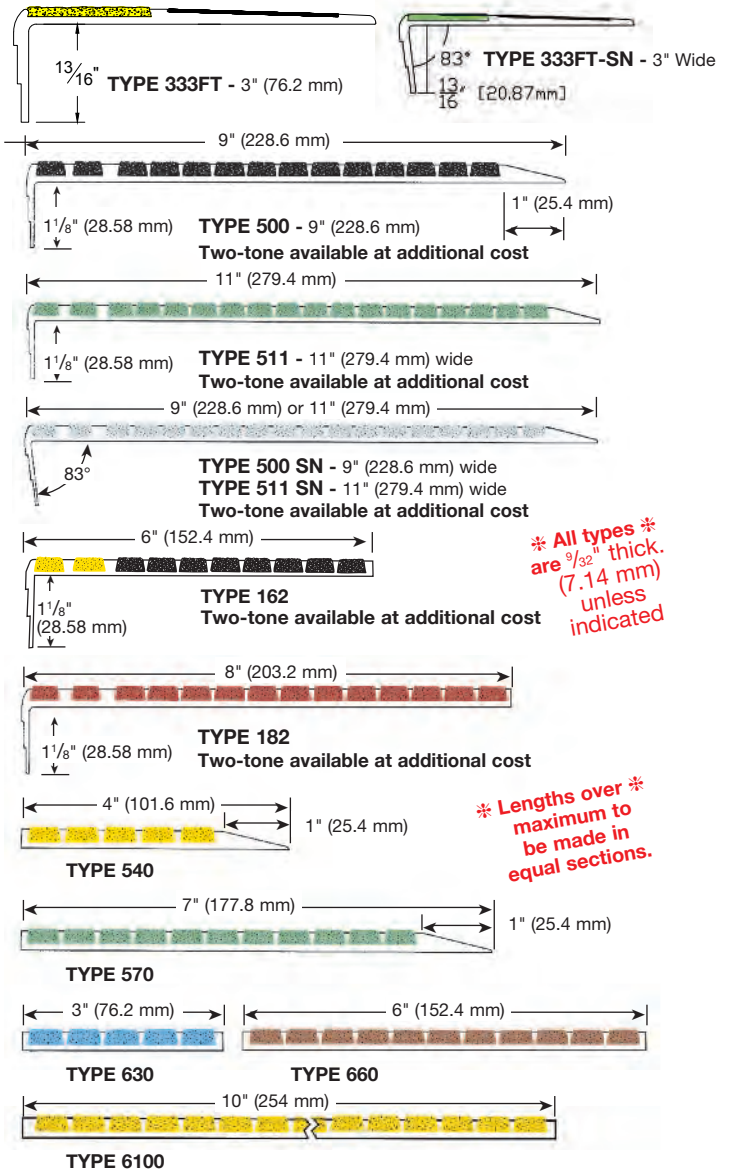



**STAIRMASTER®**  
Safety Existing  
Buildings Treads

Specify Stairmaster® For:

- Heavy Pedestrian Traffic
- Indoor, Outdoor Installation
- Excellent Safety Protection at Low Cost
- For Existing Stairs
- Non-combustible



# “STAIRMASTER®” Coverage of Landings



Full or partial coverage can be provided on landings.

Use treads below to cover depths greater than 11 inches. In addition to landings, treads can be used for applications like floors behind cafeteria counters, door sills, ramps, floor divisions, industrial platforms and in front of machines.

**EXAMPLES OF TREAD TYPES USED TO COVER A LANDING**



**TYPES OF LANDINGS**

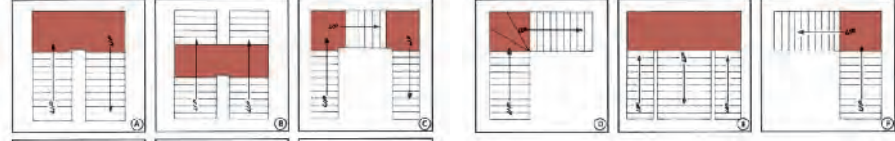

## AVAILABLE STAIRMASTER® COLORS

Standard color is black. Black will be shipped unless another color is specified. See color chart below for other colors available.



Actual tread color may vary slightly from printed sheet. Request tread sample if color is critical.

## LEVELING COMPOUND



Leveling Compound is supplied in 50-lb pails and consists of specially formulated components. Just add water, mix and compound is ready for troweling. It will not shrink as it dries and can be featheredged. One drum covers 50 square feet of surface in 1/8" thickness. Compound adheres to most surfaces; wood, concrete, steel, marble, etc. No primer required.

## HEAVY DUTY CONSTRUCTION ADHESIVE

- 12 - 10.5 oz. cartridges per case
- VOC Compliant
- Use in addition to mechanical fasteners
- Coverage 70 lineal feet of tread per case, 5/16" bead



Kapi'olani Community College. Honolulu, HI.  
Stairmaster® treads are corrosion resistant, and can be used near beaches, on boats, and for other marine applications.

## BEFORE AFTER

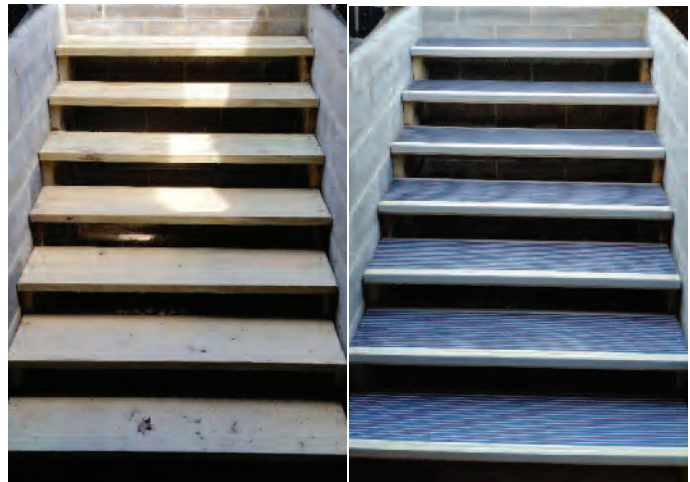





# SAFETY TREADS FOR EXISTING BUILDINGS AND STAIRWAYS

## FLEXMASTER®

Flexmaster® provides a convenient, easily replaceable solution for making stairways slip resistant. Our state of the art aluminum base protects the edges of the anti-slip surface while prolonging the lifespan of your stairway.

### Flexmaster® Benefits

- Aluminum base and Flex-Tred® anti-slip surface provide long lasting safety.
- Weather & corrosion resistant, perfect for indoor or outdoor use.
- Meets or exceeds OSHA, ASTM, and ADA requirements.
- Pre-drilled for ready to install convenience, can also be installed with construction adhesive only.
- Available in all Flex-Tred® colors- including NITEGLOW®.
- Inexpensive and easily replaceable if surface becomes worn.

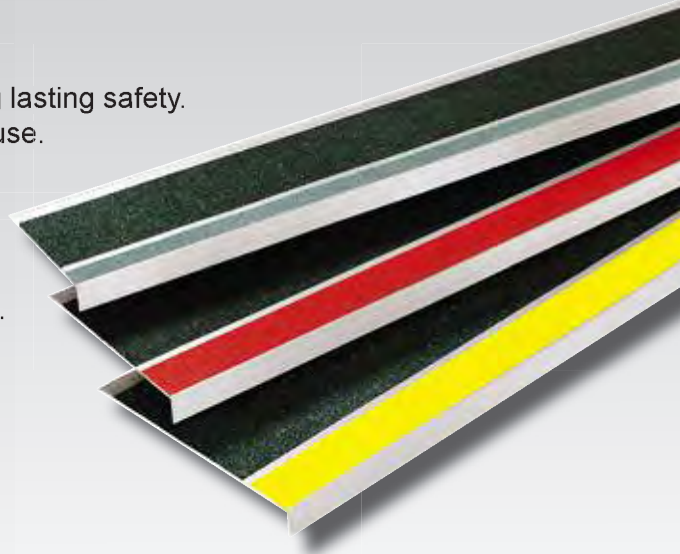

### Flexmaster® Specifications:

- Sizes available: Type 365- 6 1/2" wide, Type 300- 9" wide, and Type 311- 11" wide
- Maximum piece length is 12'-0" in one section.
- The Flex-Tred® anti-slip surface is chemically bonded onto the extrusion with a permanent type acrylic pressure-sensitive adhesive capable of 7.3 lbs. per sq. in. peel strength.
- Treads are non-combustable as tested under Federal Test Method Standard No. 501a, Method 6411, Mil-D-STD-1623D. Treads meet Motor Vehicle Safety Standard No. 302, Mil-W-5044C Type IV. Treads are U.S.D.A approved. Treads have a coefficient of friction per specification Mil-D-17951E that is equal to or greater than 1.24 Dry and 1.02 Wet.
- The tread base is made of alloy 6063-T5 extruded aluminum, with a 5/32" minimum thickness.
- The safety treads are furnished straight and free from defects. All exposed aluminum will have a satin-lacquered finish. Color extends uniformly throughout the abrasive surface; available in many contrasting colors.
- Treads are furnished with countersunk holes unless otherwise specified.
- Standard fasteners include zinc coated Tapcon screws, screws and expansion shields, wood or machine screws, and nuts and bolts.
- The use of construction adhesive is recommended.

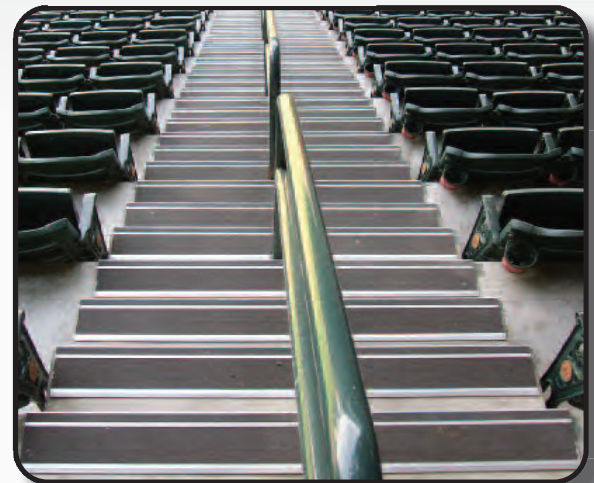

Flexmaster® is cost efficient and reliable, making it ideal for stadiums, arenas, and other large venues.

### FLEXMASTER® DIMENSIONS

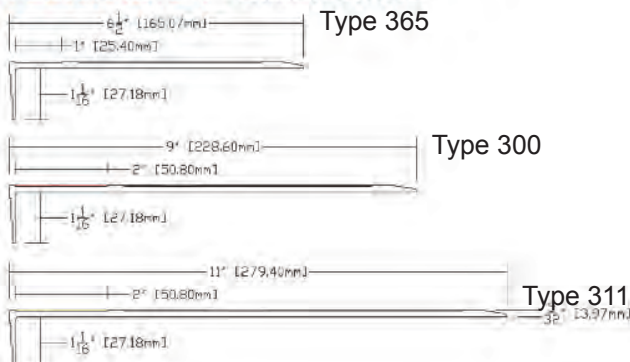

Chase Field - MLB stadium in Phoenix, AZ.  
Home of the Arizona Diamondbacks.

EXISTING BUILDINGS

## FASTENERS

Use the list below to help determine which fastener is best for your specific application. Using a heavy duty construction adhesive (Pg. 19) with mechanical fasteners will provide the strongest hold and best results.

<b>BOTH EXTRUDED &amp; CAST TREADS</b>	<p><b>Zinc Machine Screws</b> Countersunk W/ Phillips Head #10-24 (¾" And 1¼" Lengths) or ¼"-20 (¾ And 1½ Lengths) <i>Primary Use:</i> Bolt extruded treads to steel pan or concrete.</p>	
	<p><b>Stainless Steel Machine Screws</b> Countersunk W/ Phillips Head #10-24 (¾" And 1¼" Lengths) or ¼"-20 (1½ Long) 18-8 Stainless Steel, <i>Primary Use:</i> Bolt extruded treads to steel pan or concrete in corrosive environments or marine applications.</p>	
	<p><b>#10-24 Hex Nut</b> #10-24 or ¼"-20 Zinc or Stainless Steel available, use same type as screw. <i>Primary Use:</i> Bolt extruded treads to steel pan return or to secure wing anchors. Use with Stainless Steel Machine Screws.</p>	
	<p><b>Wing Anchor</b> Mild Steel or Stainless Steel, 1½"L x ¾"W x ⅝"H <i>*Always include hex nuts on order, stainless steel must be specified*</i> <i>Primary Use:</i> Cast products in new concrete. Attached to tread with machine screws &amp; nuts.</p>	
	<p><b>Zinc Wood Screw</b> Countersunk W/ Phillips Head #10 x 1½ or #14 x 1½ <i>Primary Use:</i> Extruded products on wood stairs</p>	
	<p><b>Stainless Steel Wood Screw</b> Countersunk W/ Phillips Head #10 x 1½ or #14 x 1½, 18-8 Stainless Steel <i>Primary Use:</i> Extruded products on wood stairs in corrosive environments</p>	
<b>EXTRUDED ONLY</b>	<p><b>3/16" Tapcon Screw</b> Corrosion Resistant, Countersunk W/ Phillips Head 1¼" and 1¾" Lengths (1¼ Length screws are blue w/ black heads) <i>Primary Use:</i> Extruded products to existing concrete or masonry.</p>	
	<p><b>Expansion Shields</b> #10 or ¼" Expansion Shield &amp; Lead Wood Shield <i>Primary Use:</i> Anchor tread to an existing surface, such as concrete or masonry. Use #10 or ¼" Expansion Shields with their respective machine screws, and use Lead Wood Shield with zinc or stainless steel wood screws.</p>	 <p>#10 or ¼" Expansion Shield      Lead Wood Shield</p>
	<p><b>#8-32 x ¾" Self-Tapping Zinc Machine Screw</b> Countersunk W/ Phillips Head <i>Primary Use:</i> Attaches inserts to base <b>FOR 2-STAGE WOOD &amp; INSERTS ONLY</b></p>	
<b>CAST ONLY</b>	<p><b>Concealed Integral Anchor (Cast On Anchor)</b> Aluminum. Approx. 1" long. <i>Primary Use:</i> Cast treads in new concrete. Only on types 100, 101, 101SP, 102, 103, 104, 105A, and 116 but <b>MUST BE SPECIFIED. FOR FOUNDRY USE ONLY!</b></p>	
	<p><b>¼" x 1¾" Tapcon Screw</b> Corrosion Resistant, Countersunk W/ Phillips Head <i>Primary Use:</i> Cast products to existing concrete or masonry. <b>FOR FOUNDRY USE ONLY!</b></p>	

**ZINC IS STANDARD, STAINLESS STEEL MUST BE SPECIFIED**  
**#10 SCREWS FOR EXTRUDED, ¼"-20 FOR CAST**



## ACCESSORIES

Wooster Products carries a variety of accessories, cleaners and compounds to help you efficiently and effectively install your new anti-slip products. These accessories are specially formulated to keep our safety treads, tapes, and coatings secure under heavy use and in a wide range of environmental conditions.



### Wooster Floor Prep

Many of our products require a clean, dry surface for proper adhesion. Wooster Floor Prep is an effective alkaline cleaning compound recommended for cleaning all types of interior and exterior floor surfaces prior to applying Flex-Tred, Heavy Duty Construction Adhesive, Walk-A-Sured, or Epoxy WP-70.

**Coverage:** Each 4 oz. bottle will clean approximately 50 sq. ft.



### Heavy Duty Construction Adhesive

When used in addition to mechanical fasteners, this super strong adhesive will help keep your tread or nosing properly anchored. Heavy duty construction adhesive is VOC compliant, and comes in cases of twelve 10.5 oz. tubes.

**Coverage:** 70 lineal feet of tread per case when applied in a 5/16" bead.



### Wooster Products Leveling Compound

Our specially formulated leveling compound can be applied to wood, concrete, steel, marble, etc. No primer required. Just add water, mix and trowel compound to provide a level bearing surface for treads. It will not shrink as it dries, and can be featheredged to 5/8" thick - without aggregate.

**Coverage:** Each 40-lb pail covers 101 sq. ft. at 1/16" thickness.



### Wooster Products Edge Sealing Compound

Wooster Products' Edge Sealer is used with Flex-Tred® in applications where exposure to liquids is expected. Edge sealer is VOC free and sticks to most surfaces, including concrete, metal, wood, rubber, plastics, and fiberglass. Dries to tack free in under 1 hour, and cures completely overnight.

**Coverage:** Each 5 oz. tube covers approximately 100 lineal feet when applied in a 3/16" bead.



### Seam Roller

Seam rollers are a simple and effective way to ensure proper adhesion of Flex-Tred® and Flex-Mark tapes. Works great along seams, edges, or uneven surfaces.



### Floor Tape Dispenser

This innovative new dispenser makes floor tape application a breeze - no squatting or kneeling required! Can be quickly loaded with any 2", 3" or 4" wide roll of Flex-Tred® or Flex-Mark tape. Includes a built-in guide arm so you get a perfect line every time.



# FLEX-TRED®

## Anti-Slip Safety Rolls, Cleats & Strips for Indoor or Outdoor Use

### FLEX-TRED®

Flex-Tred® heavy-duty safety surface is quick to install and provides durable pedestrian safety on slippery surfaces. Uses: ramps, light traffic stairs, exercise equipment, industrial equipment, aisles, entrances, skateboards.

Flat black medium is a standard color and will be furnished unless another color is specified.

**Black Textures:** Sparkle Black, Ultragrip Black, Flat Black Extra Coarse, Flat Black Coarse, Flat Black Medium, Marine Black, Flat Black Fine, Super Fine Black.

**General Note:** Standard tolerance  $\pm 1/16"$

### STANDARD ROLL SIZES

3/4" x 60 ft. - packed	16 rolls per carton
1" x 60 ft. - packed	12 rolls per carton
2" x 60 ft. - packed	6 rolls per carton
3" x 60 ft. - packed	4 rolls per carton
4" x 60 ft. - packed	3 rolls per carton
6" x 60 ft. - packed	2 rolls per carton
8" x 60 ft. - packed	3 rolls per carton
12" x 60 ft. - packed	1 roll per carton
18" x 60 ft. - packed	1 roll per carton
24" x 60 ft. - packed	1 roll per carton

Custom Sizes On Request  
Standard tolerance  $\pm 1/16"$

### STANDARD DIE-CUT SIZES

All standard sizes are packed 50 pieces each carton.

#### STRIPS AND CLEATS STANDARD CUT SIZES:



6" x 24"



Custom sizes for rolls and die cuts available by request.



5 1/2" x 5 1/2"

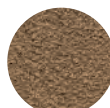

5 1/2" Dia.



6" x 9" Arrow

### MOP FRIENDLY MARINE & POOL COLORS

With a special design for bare feet, Flex-Tred®'s abrasive surface is adhesive backed, economical and easily installed. Special shapes available for OEMs. Ready for immediate use on pool decks, ramps, pleasure crafts, fishing docks, and boats. Order from our standard size rolls, standard die-cut sizes, or custom order your own die cut shape.



Teak Brown

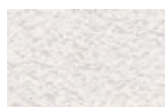

Pebble White



Clear Fine



Marine Black

Use edge sealer for wet environments.

### FLEX-TRED® COLOR CHART

Color coordinate with Flex-Tred® – key to decor – show contrast. Our variety of colors gives you a variety of options. Grades of coarseness, available only in black.

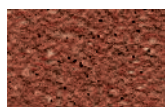

Industrial Red



Industrial Brown

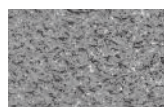

Ocean Gray



Striped Safety

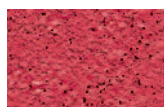

Scarlet Red



Safety Yellow

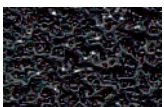

Standard Black



Clear Coarse



NITEGLOW®  
Glow in the Dark

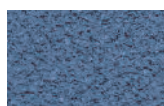

Caribbean Blue



### Wooster Products Floor Prep

Wooster Floor Prep is an effective alkaline compound recommended for cleaning all types of floor surfaces, prior to applying Flex-Tred®. Coverage: Each 4 oz. bottle will clean approximately 50 sq. ft.



### Wooster Products Clear Edge Sealer

Wooster Products' Edge Sealer is used with Flex-Tred® in applications where exposure to liquids is expected. Edge sealer is VOC free and sticks to most surfaces, including concrete, metal, wood, rubber, plastics, and fiberglass. Dries to tack free in under 1 hour, and cures completely overnight. Each 5 oz. tube covers approximately 100 lineal feet when applied in a 3/16" bead.



### Seam Roller

Use on seams, edges, or uneven surfaces.

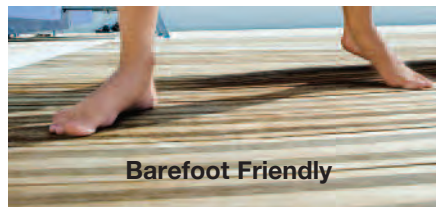

Barefoot Friendly

EXISTING BUILDINGS

\*Actual color may vary slightly from printed sheet. Request sample if color is critical.

\* National Safety Council information



# FLEX-TRED®

## Anti-Slip Safety Rolls, Cleats & Strips for Indoor or Outdoor Use

### APPLICATIONS

Anywhere You Need an Anti-Slip Surface

#### Walkways

- stairs • entrances • ramps • docks • pool areas • porches
- decks • balconies • ski-lift access areas • catwalks
- patios • galleys • etc.

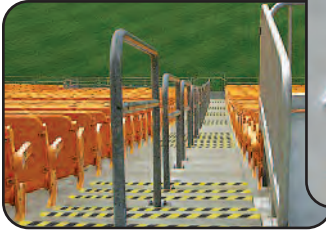

#### Product

- recreational vehicles (campers, motor homes, trailers)
- exercise equipment • lawn and garden equipment
- lift trucks • ladders • trucks • construction equipment
- farm tractors and equipment
- playground equipment • skateboards • skis
- spas • utility vehicles • boats • aircraft
- baggage handling equipment • snowmobiles
- golf carts • bumpers • running boards • etc.

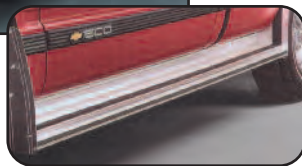
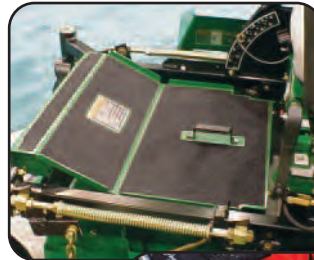

#### Workplace

- around work benches • laundries
- machinery work stations • kitchens
- platforms • scaffolds • cherry pickers
- boiler and furnace areas • etc.

### FLEX-TRED® Improves Coefficient of Friction of Most Surfaces in Wet or Dry Use

Coefficient of friction tests run per specification Mil-D-17951C (ships) using rubber test vehicle. Higher numbers indicate better coefficient of friction.

#### COMPARISON OF VARIOUS SURFACES: STATIC COEFFICIENT OF FRICTION

	Dry Surface Test Results	Wet Surface Test Results		Dry Surface Test Results	Wet Surface Test Results
<b>FLEX-TRED® Surfaces</b>			<b>Other Surfaces</b>		
Flat Black Coarse	1.33	1.21	Ribbed Rubber	.89	.76
Sparkle Black	1.24	1.06	Scotch Tred	.69	.50
Blue Medium	1.29	1.09	Painted Steel	.77	.69
Flat Black Fine	1.37	1.17	Textured Vinyl	.80	.64
Ocean Grey	1.30	1.02	Ribbed Vinyl	.85	.72

Flex-Tred® meets or exceeds specifications for: Mil-D-17951E (ships); Motor Vehicle Safety Standard No. 302; Walkway Matting, Non-slip Mil-W-5044C, Type IV, ADA, ASTM and OSHA.

### GENERAL PROPERTIES

- **Flexibility** - Flex-Tred® bends over sharp 90° angles without fracture. Repeated bending without cracking or failure of bond.
- **Temperature Limits** - Applied Flex-Tred® has a useful temperature range of -40°F to 220°F. However, limited exposure to temperatures above 220°F will not harm Flex-Tred®.
- **Steam Cleaning** - Applied Flex-Tred® will tolerate steam cleaning.
- **Detergent Cleaning** - Applied Flex-Tred® will tolerate detergent cleaning.
- **Environmental Resistance** - Flex-Tred® is essentially unaffected by climactic exposure and mild acid or alkali exposure under normal conditions.
- **Shelf Life** - Flex-Tred® shelf life is two years minimum.

### BENEFITS

- **Anti-slip** wet or dry
- **Reduces liability exposure**
- **Quick & Easy to Install**
- **Economical**
- **Durable** - long wearing
- **Super Adhesion**  
A heavy coating of specially formulated pressure-sensitive adhesive
- **Resistant to Solvents**
- **Die Cuts** available to fit your application.
- **Colors available**

EXISTING BUILDINGS



# FLOOR MARKING TAPE FOR WAYFINDING & IDENTIFICATION

## FLEX-MARK

Flex-Mark is a heavy-duty PVC floor tape used for wayfinding, identification, and organization in a variety of industries. It is cost effective, simple & safe.



### FLEX-MARK Benefits

- Create safe equipment and pedestrian traffic lanes.
- Mark hazardous areas where extra caution or PPE is required.
- Identify borders of workstations, machines, racks, equipment etc.
- Helps with inventory management and organization.
- Strong PVC material can withstand traffic from forklifts and other machines.
- Requires less prep time than paint, has no harsh fumes, and is mess free.
- Markings are easily cleaned for maximum visibility and safety.
- Super strong peel and stick adhesive makes it easy to apply and leaves no residue.

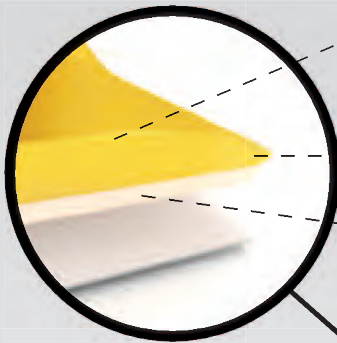

- 7 Time thicker than average floor tape
- Beveled edge prevents snags and increases durability for forklift traffic
- Peel and stick adhesive leaves no messy residue

Close up view of Flex-Mark.



Flex-Mark tape is made from PVC material, which allows it to withstand forklift traffic without tearing.

Flex-Mark is an excellent tool for marking important workplace boundaries such as paths, storage, and hazardous areas. Flex-Mark provides a strong visual cue to make it easier for people to get around safely. It can improve both efficiency and safety in manufacturing facilities, warehouses, construction sites, and more.

100 Foot stock roll sizes: 2" wide   3" wide   4" wide	
Stock Colors:	Common Uses:
<b>YELLOW</b>	Outlines safe pathways, aisles, and lanes in areas with pedestrian and equipment traffic.
<b>RED</b>	Marks boundaries of dangerous or red tag areas, as well as emergency exit areas.
<b>YELLOW &amp; BLACK STRIPED</b>	Used in areas that require extra caution due to health or safety hazards.

Additional colors available by request, contact Wooster Products for details.

### FLOOR TAPE DISPENSER

This innovative new dispenser makes floor tape application a breeze! Includes guide arm so you get a perfect line every time.



Works with all 2", 3" and 4" wide rolls of Flex-Tred® and Flex-Mark tape.



# Safety Coating Systems

## PAINT

### SAFE-STRIDE®

#### Moderate Traction and Durability for Foot Traffic

- Meet OSHA and ADA standards
- Meet ASTM slip resistance requirements.
- Indoor and Outdoor Applications • Custom Colors Available
- Coatings contain aluminum oxide or zirconium grit which give the coatings long-lasting added traction.

#### LOW VOC ACRYLIC

- Durable traction grit
- Adheres to concrete, wood, primed metal, asphalt, marble, and stone
- Easy application
- Easy clean-up
- Apply with brush or paint roller



#### OIL BASE

- Durable traction grit
- Use preferred over acrylic for heavier traffic surfaces
- Easy application
- Apply with brush or paint roller



Black



Gray



Safety Yellow



Gray



## EPOXY COATINGS

### WALK-A-SURED® & EPOXY WP-70®

#### VOC FREE WALK-A-SURED® High Traction and Durability for Vehicle and Foot Traffic

#### LOW VOC EPOXY WP-70® Extreme Traction and Durability for Industrial Traffic

- Meet OSHA and ADA standards • Meet ASTM slip resistance requirements.
- Indoor and Outdoor Applications • Custom Colors Available
- Coatings contain aluminum oxide or zirconium grit which give the coatings long-lasting added traction.

#### WALK-A-SURED® WATER CLEAR EPOXY

- Chemical, solvent and water resistant
- Enhances traction on a variety of surfaces
- 100% solids - **NO VOCs!**
- 2-part Epoxy system
- Barefoot friendly available



Clear

#### New Features

- Specially formulated quick set system that will provide a clear, yet sure-footed and safe traction surface.
- Available in three formulas to meet the needs of any project.



#### WALK-A-SURED® ROLL-ON

- Chemical, solvent and water resistant
- Enhances traction on a variety of surfaces
- 100% solids - **NO VOCs!**
- 2-part Epoxy system



UV  
RESISTANT



Gray



#### EPOXY WP-70®

#### NO FLASH OR VOLATILE SOLVENTS LOW VOC

#### TROWEL-ON

- 2-part Epoxy system for durable, long-lasting solution
- For industries such as breweries, canneries, off-shore drilling platforms
- Renews damaged ramps and floors in one coat.
- Extra thick consistency requires trowel or squeegee application



Black



Gray



## WP COATINGS

Colors Available

Container Size

Storage Application

Approximate Coverage Sq. Ft.

Cure Time at 75° F

Method of Application

Application Temp.

Working Temp.

Pot Life Minute

Approximate Coefficient of Friction Dry

Approximate Coefficient of Friction Wet

Meets OSHA ADA & USDA Guidelines

### PAINT COATINGS MODERATE TRACTION AND DURABILITY FOR FOOT TRAFFIC

<b>LOW VOC SAFE-STRIDE® Acrylic</b>	Black, Gray, Safety Yellow	1 Gallon	50° to 90°	100-125	2-4 hrs.	1/4" Nap Roller	50° to 90°	40°-110°	N/A	.97	.79	Yes
<b>SAFE-STRIDE® Oil-Base</b>	Gray	1 Gallon	50° to 90°	100-125	12 hrs.	1/4" Nap Roller	50° to 90°	20°-110°	N/A	.87	.83	Yes

### EPOXY COATINGS • VOC FREE WALK-A-SURED® HIGH TRACTION AND DURABILITY FOR VEHICLE AND FOOT TRAFFIC • LOW VOC EPOXY WP-70® EXTREME TRACTION AND DURABILITY FOR INDUSTRIAL TRAFFIC

<b>VOC FREE WALK-A-SURED® Water Clear</b>	Clear	1 Gallon Kit	65° to 80°	150-275	8 hrs.	1/4" Nap Epoxy Roller	55° to 100°	20°-110°	25-35	.80-1.07	.76-1.02	Yes
<b>VOC FREE WALK-A-SURED® Roll-On</b>	Gray	1 Gallon Kit	65° to 80°	125-175	18-24 hrs.	1/4" Nap Epoxy Roller	55° to 100°	20°-110°	30-60	.97	.80	Yes
<b>LOW VOC EPOXY WP-70®</b>	Black, Gray	1 Gallon Kit	65° to 80°	25-35	18-24 hrs.	Squeegee	55° to 100°	-40° to +180°	30-60	.92	.76	Yes

No extra hazardous shipping charges, with the exception of Safe-Stride® oil base. Epoxies and oil base Safe-Stride® cannot ship by air.



# Anti-Slip Safety Stair and Walkway Products



Sports Stadiums



Serving You  
Since 1921!



Custom Cutting



Public Walkway Safety



OEM Supplier



## Find us at:

- |            |            |
|------------|------------|
| Sweets     | BIMobject  |
| ARCAT      | Bimsmith   |
| 4specs.com | CADdetails |
| Thomasnet  | Shipserv   |



Marine Anti-Slip Safety

© Copyright 2021 WOOSTER PRODUCTS INC

## WOOSTER PRODUCTS INC

1000 Spruce Street • P.O. Box 6005  
Wooster, Ohio 44691

Phone: (330) 264-2844 • Fax: (330) 262-4151  
Toll Free Phone: 1-800-321-4936

Application Consulting:  
refer to website for local support

Web Site: <http://www.woosterproducts.com>  
E-Mail: [Sales@wooster-products.com](mailto:Sales@wooster-products.com)

See Sweets Catalog, Blue Book and Thomas Register



Stair Components & Systems  
A Division of Eberl Iron Works, Inc.

128 Sycamore St  
Buffalo, NY 14204  
(800) 285-3056

[fab@eberliron.com](mailto:fab@eberliron.com)

[stairpans.com](http://stairpans.com)

Printed in U.S.A.

Wooster Products Inc. reserves the right, without notice, to make changes in specifications, construction or design of any products at any time in such manner as we may consider necessary, or advisable, and to discontinue the manufacture and sale of any products.

**IMPORTANT NOTICE TO PURCHASER: THE FOLLOWING IS MADE IN LIEU OF ALL WARRANTIES, EXPRESSED OR IMPLIED, INCLUDING WARRANTIES OF MERCHANTABILITY AND FITNESS FOR A PARTICULAR PURPOSE:** Purchase or use of this product constitutes an agreement with Seller and Manufacturer that, if the product proves to be defective or in any way unsuitable, Seller's and Manufacturer's limit of liability for all damages, including but not limited to incidental or consequential damages, and User's or Purchaser's exclusive remedy, regardless of legal theory, including theories of breach of warranty, negligence and strict liability, shall be to receive, at Seller's or Manufacturer's option, repair of the defective product, an equivalent quantity of replacement product or a refund of the purchase price.